

DO NOT SCALE

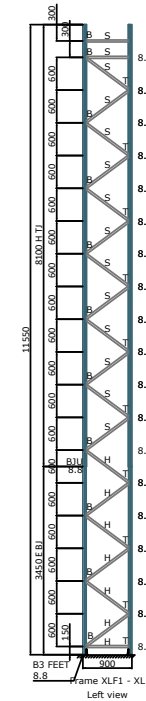

- FRAME KEY  
 T DENOTES TOP BRACING  
 B DENOTES BOTTOM BRACING  
 S DENOTES STANDARD DUTY BRACING  
 H DENOTES HEAVY DUTY BRACING  
 8.8 DENOTES GOLD BOLTS
- 1 off- KJ8100H0900ATJGXQ
  - 1 off- KJ3450E0900AB3GXQ
- Frame Component Makeup
- 2 off- H8100GX
  - 12 off- BD0900SGT
  - 2 off- BHT0900SGT
  - 4 off- SPZC
  - 27 off- SP8838HH60ZG
  - 27 off- NY38ZC
  - 2 off- E3450GX
  - 6 off- BD0900HGT
  - 1 off- BHT0900HGT
  - 2 off- B3ZC
  - 2 off- BJUGX

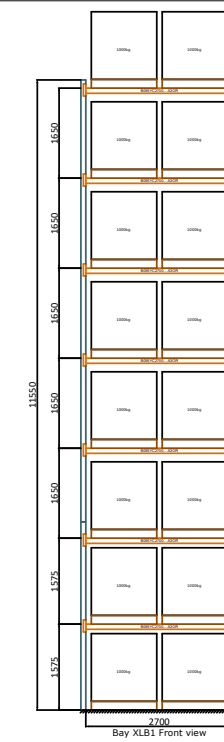
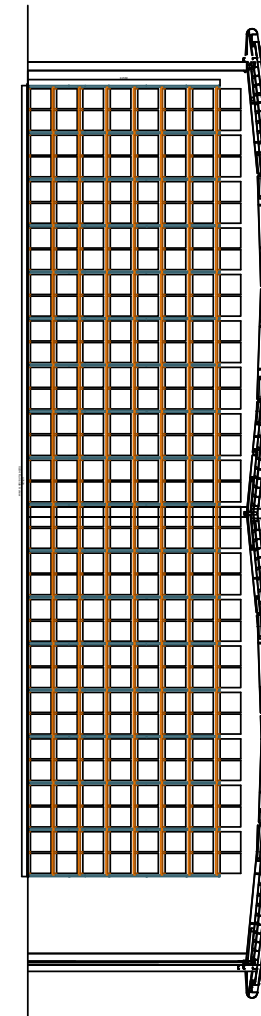
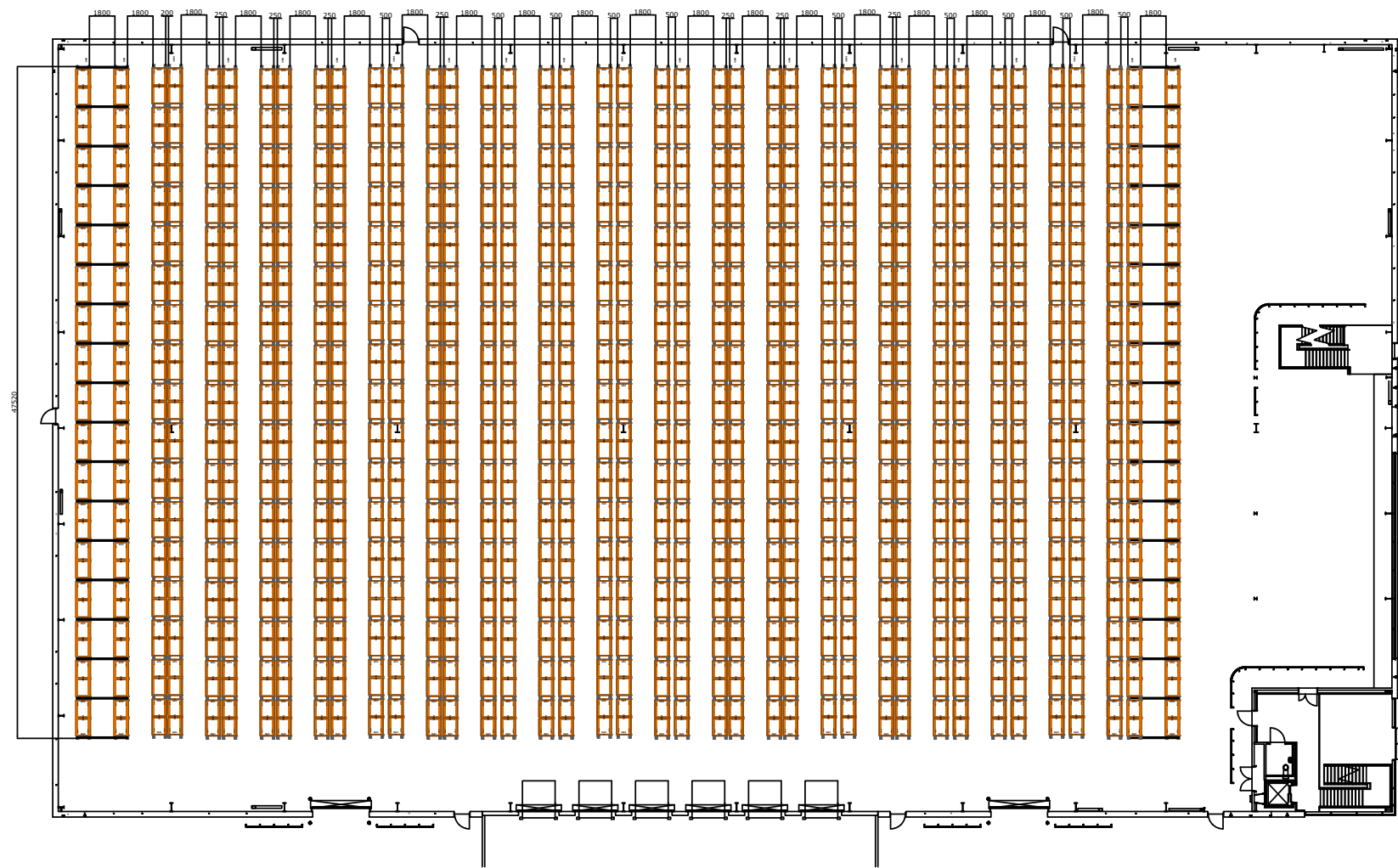
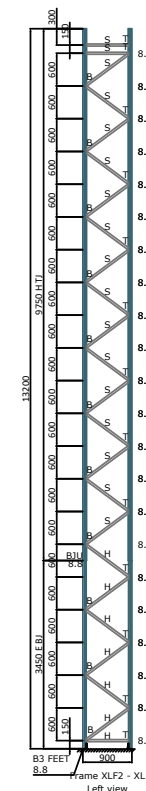
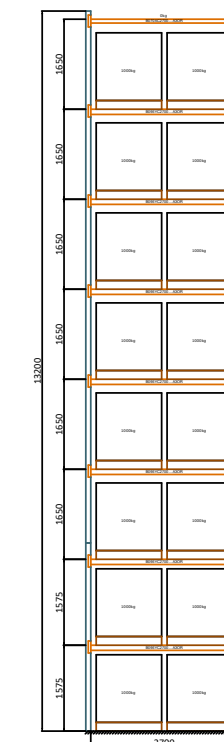

- FRAME KEY  
 T DENOTES TOP BRACING  
 B DENOTES BOTTOM BRACING  
 S DENOTES STANDARD DUTY BRACING  
 H DENOTES HEAVY DUTY BRACING  
 8.8 DENOTES GOLD BOLTS
- 1 off- KJ9750H0900ATJGXQ
  - 1 off- KJ3450E0900AB3GXQ
- Frame Component Makeup
- 2 off- H9750GX
  - 15 off- BD0900SGT
  - 2 off- BHT0900SGT
  - 4 off- SPZC
  - 30 off- SP8838HH60ZG
  - 30 off- NY38ZC
  - 2 off- E3450GX
  - 6 off- BD0900HGT
  - 1 off- BHT0900HGT
  - 2 off- B3ZC
  - 2 off- BJUGX

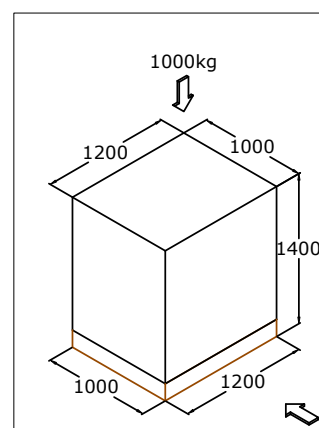

<p><b>Whittan Group Ltd.</b>                  Link House, Halesfield 6, Telford, TF7 4LN, United Kingdom                  www.whittan.com &lt;http://www.whittan.com&gt; T: +44 (0)1952 682 251</p>	Rev No.	Date	Sign	Description		Scale:	Drawn By:	Checked By:	Date:	Customer Approval:	Approval Date:
								PDL	JR	11/12/2023	
Storage Solution for Sherburn Project - Firethorn Trust UNIT 400 Narrow Aisle							Drawing and Contract number: A3 D360-57428-00024-00				
This Drawing remains the property of Whittan Group © While every attempt has been made to ensure the accuracy of the drawing contained here, measurements are indicative only and no responsibility is taken for any error, omission, or misstatement. The drawing is for initial guidance only and should not be relied on for any other purpose. Specifically, no guarantee is given as towards the accuracy of this drawing. On receipt of any formal instructions to proceed with a project the drawing/ drawings will be checked and subject to the Terms & Conditions agreed. Copyright of the document remains vested with Whittan Industrial Ltd											