

PARK PLACE

NOW LEASING

OAKPOINT



4005/4009 Banister Lane
Austin, Texas 78704



BUILDING OVERVIEW

Located a short distance from South Congress and downtown Austin, Park Place creates the ideal location for a central-focused business. With fourth floor views of Downtown Austin and the tree-filled landscaping, this four building campus is an outstanding space for all types of offices.

BUILT IN

1985

RENTABLE SPACE

41,946 sf

FLOORS

4

AVG FLOOR PLATE

13,772 sf

RENOVATED

2022

LOT

2.82 acres

PARKING RATIO

3.25:1,000

UNFINISHED CEILING HEIGHT

12'



FEATURED AMENITIES

Ample surface parking,
great highway access,
tree-filled landscaping,
and prime proximity to
Austin's top amenities.



Tree-filled landscaping



Easy access to Hwy 71,
Loop 360, MoPac &
IH 35



Monument signage available



Generous parking



Prime proximity to
Austin's top amenities



Large conference center





Top amenities in close proximity.

PARK PLACE

- 1 ZILKER**
 - Target
 - Juiceland
 - Uchi
 - Tesla Supercharging Station
 - Snooze an A.M. Eatery
 - Loro
- 2 BOULDIN CREEK**
 - Starbucks
 - Toss Pizzeria & Pub
 - Summer Moon Coffee
 - Mattie's
 - Whataburger
 - Phoebe's Diner - Oltorf
- 3 SOUTH CONGRESS**
 - Magnolia Cafe
 - Torchy's Tacos
 - H-E-B
 - Home Slice Pizza
 - Aba Austin
 - Whip In
- 4 SAINT ELMO**
 - Cathedral of Junk
 - Casa Maria
 - CVS
 - St. Elmo Brewing Company
 - The Git Out - Bar + Kitchen
 - La Flor
- 5 EAST RIVERSIDE**
 - Whataburger
 - P. Terry's Burger Stand
 - Café Crème
 - Jack in the Box
 - Planet Fitness
 - McDonald's
- 6 MCKINNEY**
 - Little Caesars Pizza
 - Bakery Cloud Nine
 - CJ's Tacos
 - Pinthouse Brewing
 - Side Eye Pie
 - Austintatious Cheesecakes





AVAILABILITY

4005 Banister Ln, Suite 100B

SIZE

4,730 sf

AVAILABILITY DATE

Available Now

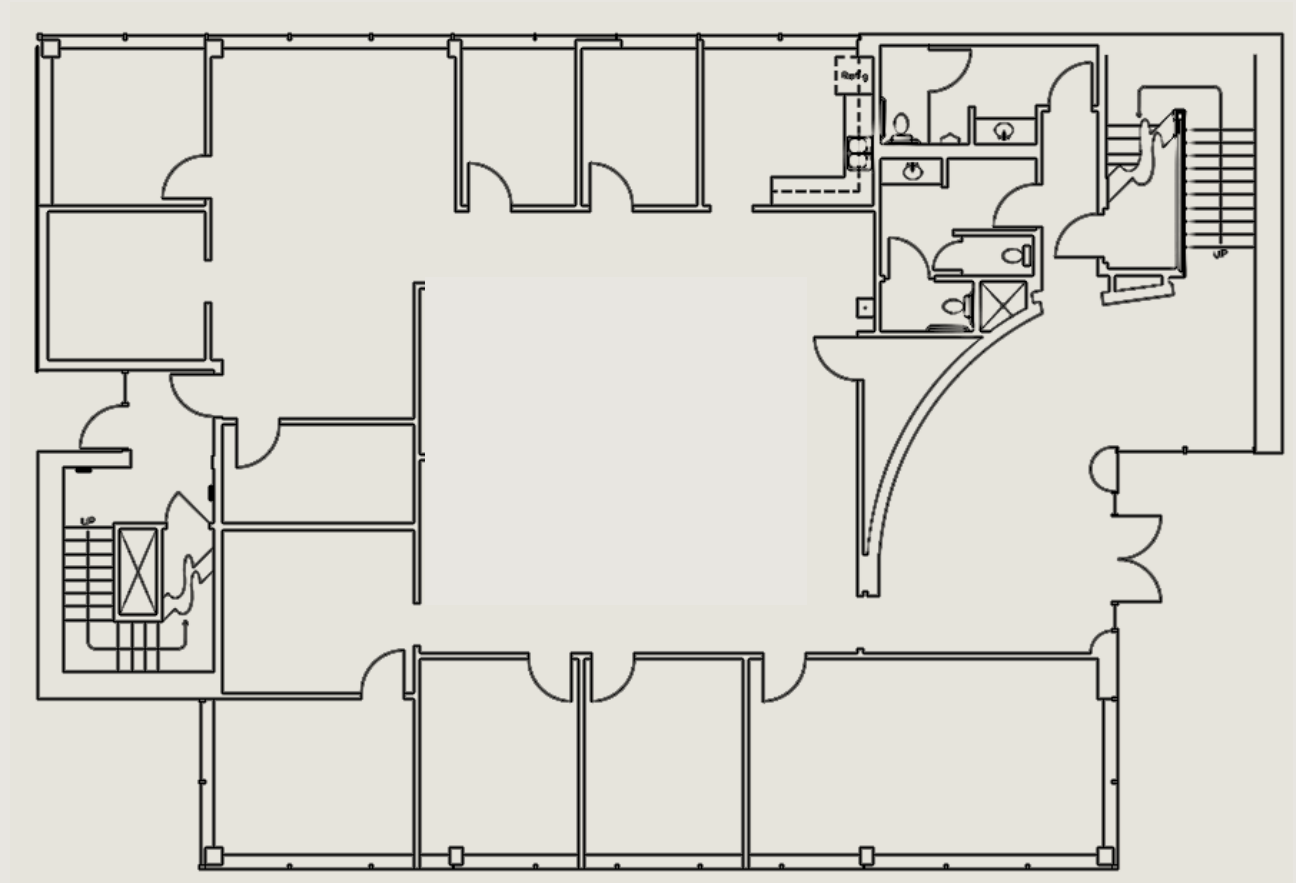



AVAILABILITY

4005 Banister Ln, Suite 245C

SIZE

642 sf

AVAILABILITY DATE

Available Now

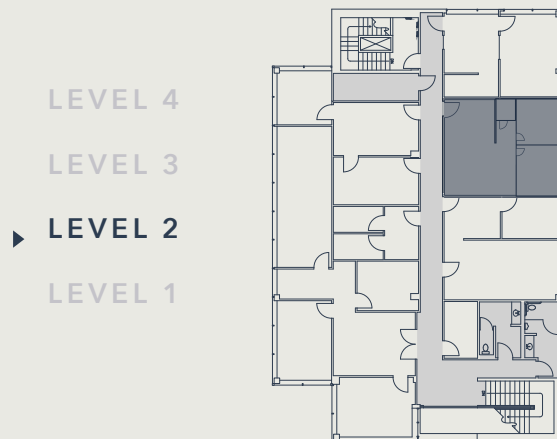
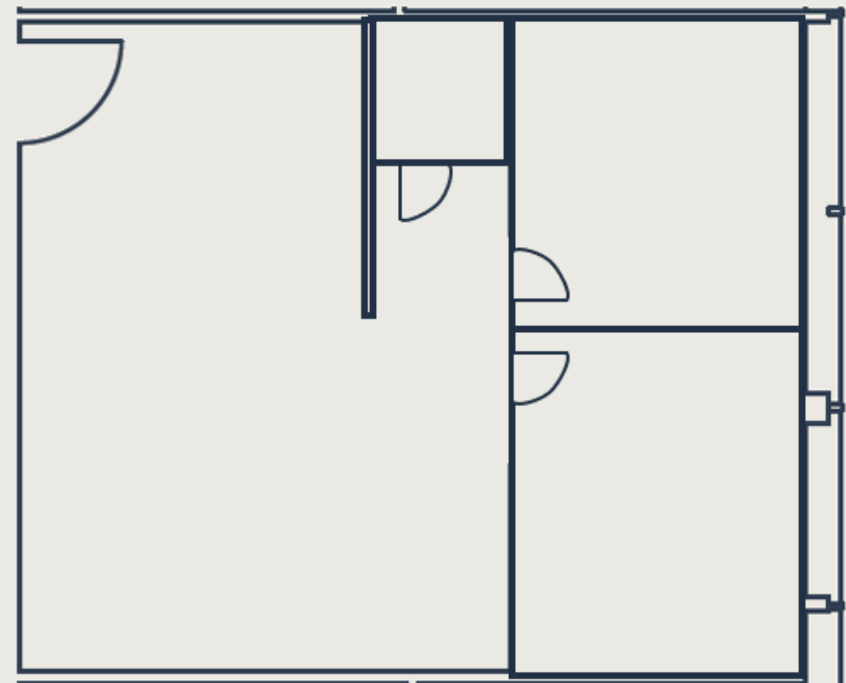



AVAILABILITY

4009 Banister Ln, Suite 102

SIZE

700 sf

AVAILABILITY DATE

8/1/2026

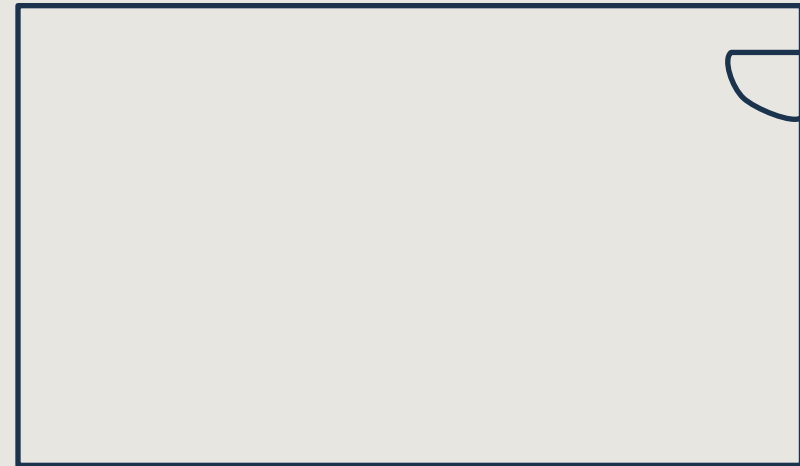

LEVEL 4

LEVEL 3

LEVEL 2

▶ LEVEL 1

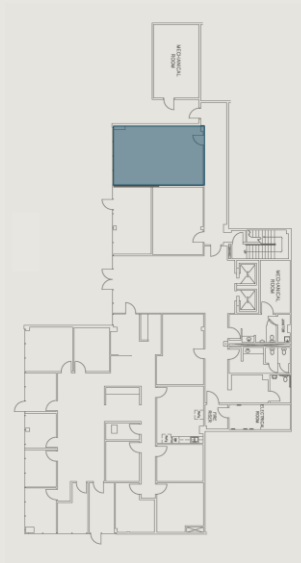



AVAILABILITY

4009 Banister Ln, Suite 250

SIZE

1,170 sf

AVAILABILITY DATE

Available Now

- LEVEL 4
- LEVEL 3
- ▶ LEVEL 2
- LEVEL 1

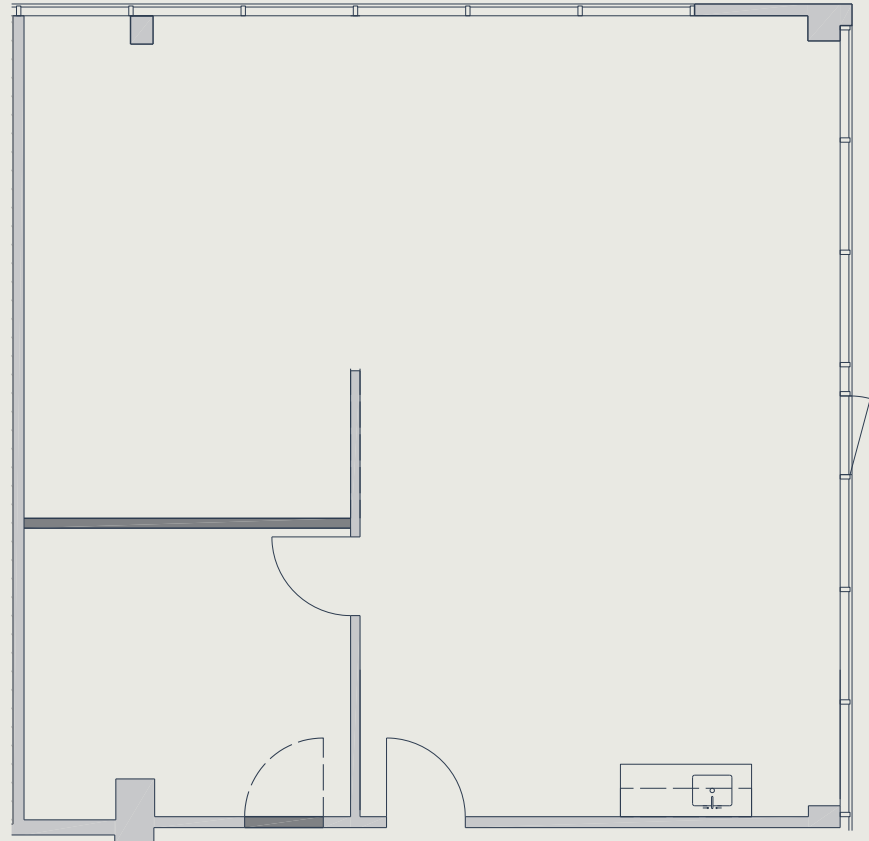
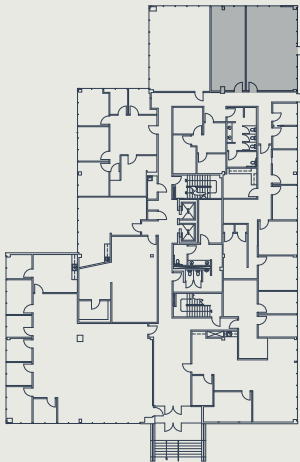



AVAILABILITY

4009 Banister Ln, Suite 300

SIZE

4,343 sf

AVAILABILITY DATE

Available Now

LEVEL 4

▶ LEVEL 3

LEVEL 2

LEVEL 1

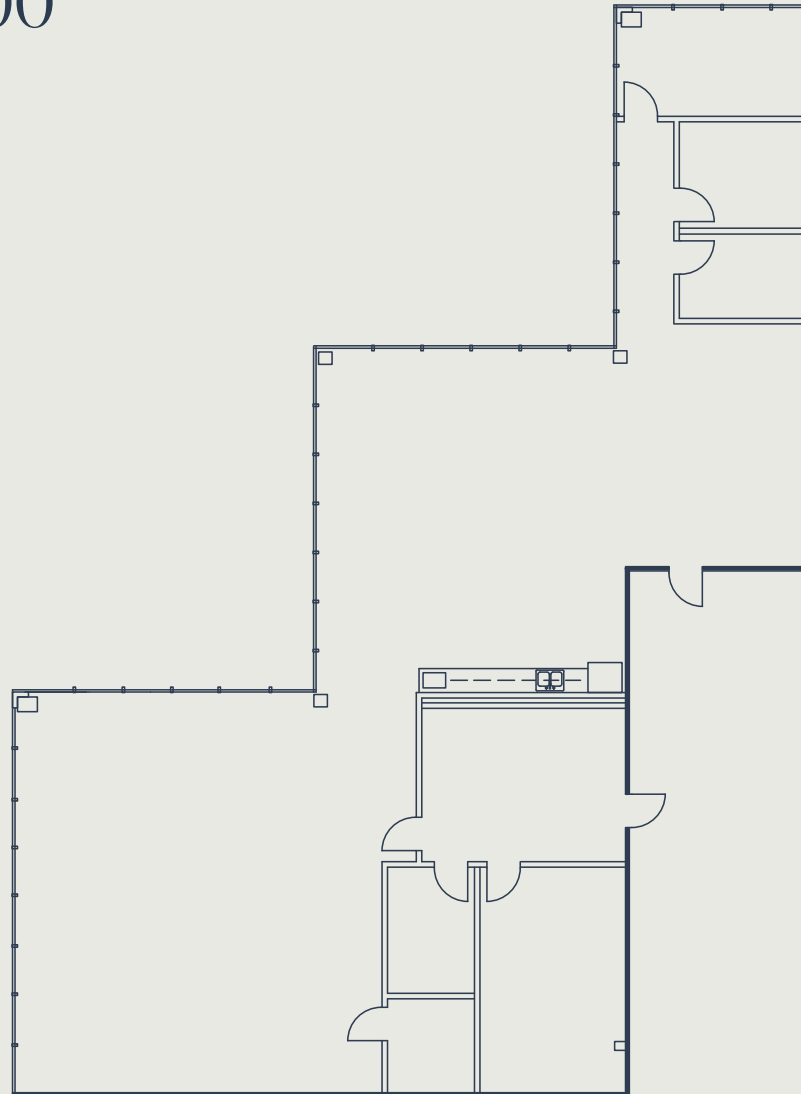
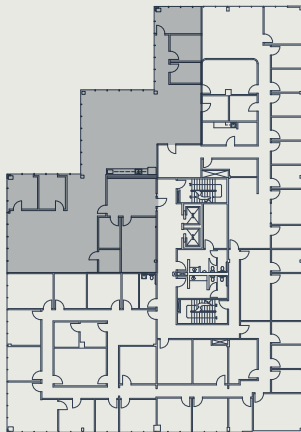



AVAILABILITY

4009 Banister Ln, Suite 355

SIZE

1,292 sf

AVAILABILITY DATE

Available Now

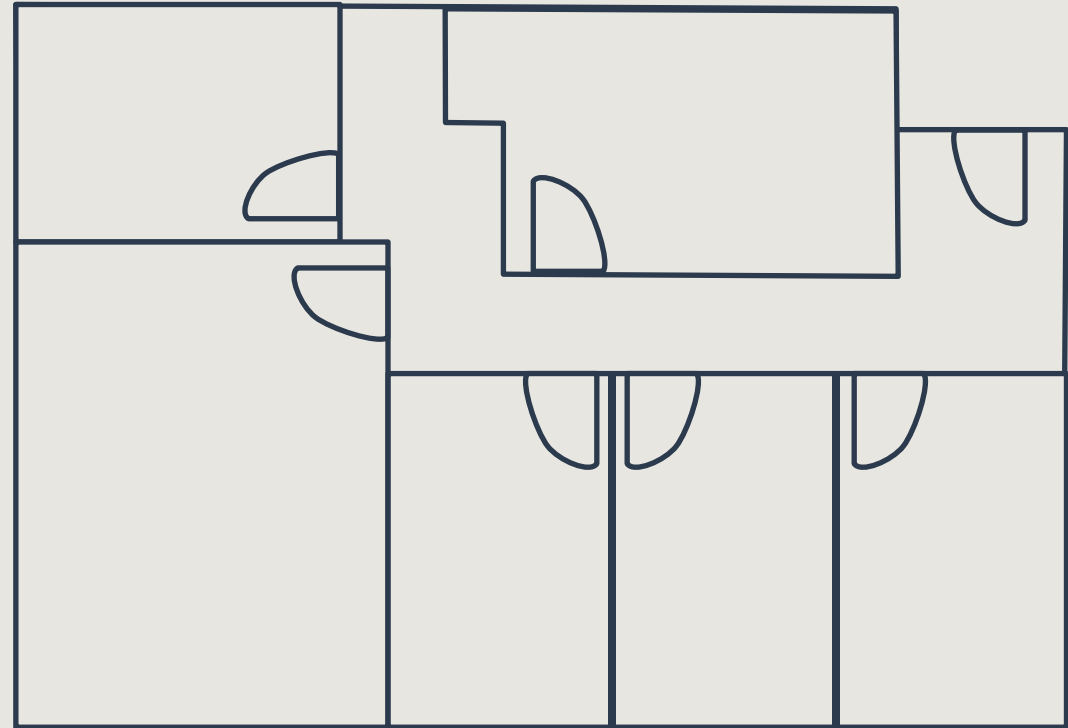



AVAILABILITY

4009 Banister Ln, Suite 400

SIZE

5,247 sf

AVAILABILITY DATE

Available Now

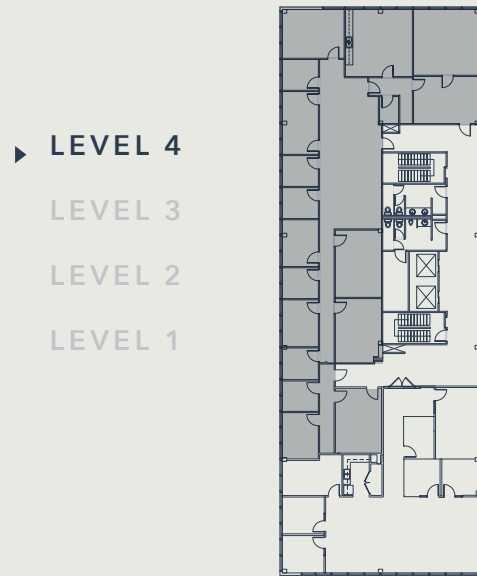
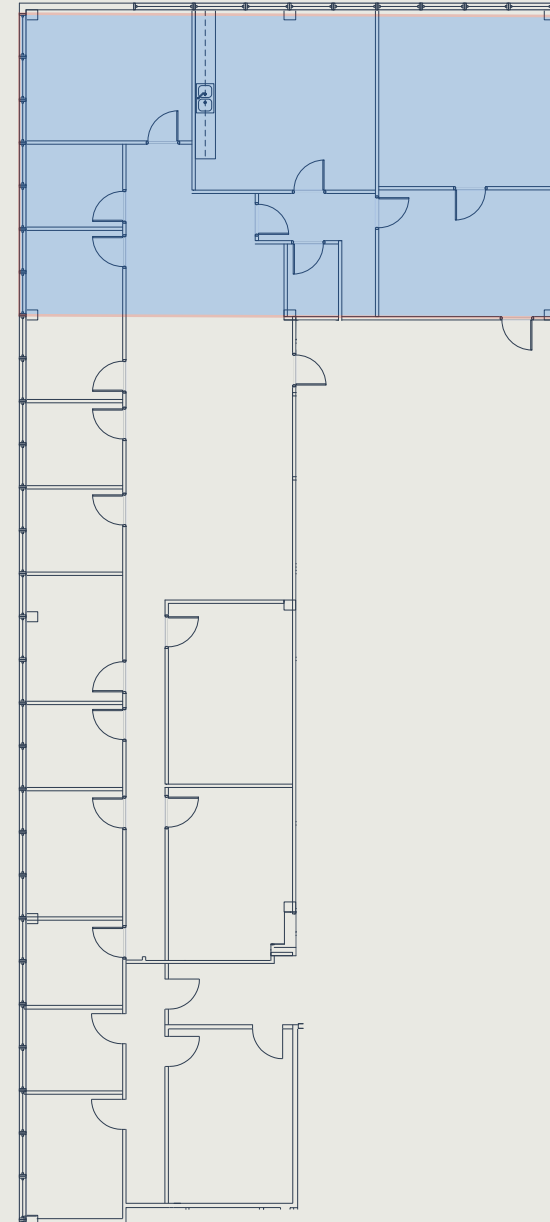



LEASING INFORMATION

Park Place is locally owned and operated by OakPoint, a vertically integrated firm with a diverse portfolio in commercial, multifamily, office, residential, and industrial real estate.

For leasing information, please contact:

RYAN BUSCHA

Director

O (512) 975-2253

E rbuscha@oakpointre.com

DAN FRICKS

Leasing

O (512) 640-6278

E dfricks@oakpointre.com

