



Megacenter MEMORIAL



1530 W. SAM HOUSTON PKWY. N. | HOUSTON, TX 77043

PROPERTY OVERVIEW:

- 147,669 SF
- Warehouse & Office/Lab
- Dock-High & Grade-Level Loading
- 17'-24' Clear Height
- Easy Access to W. Sam Houston Pkwy. and I-10 West

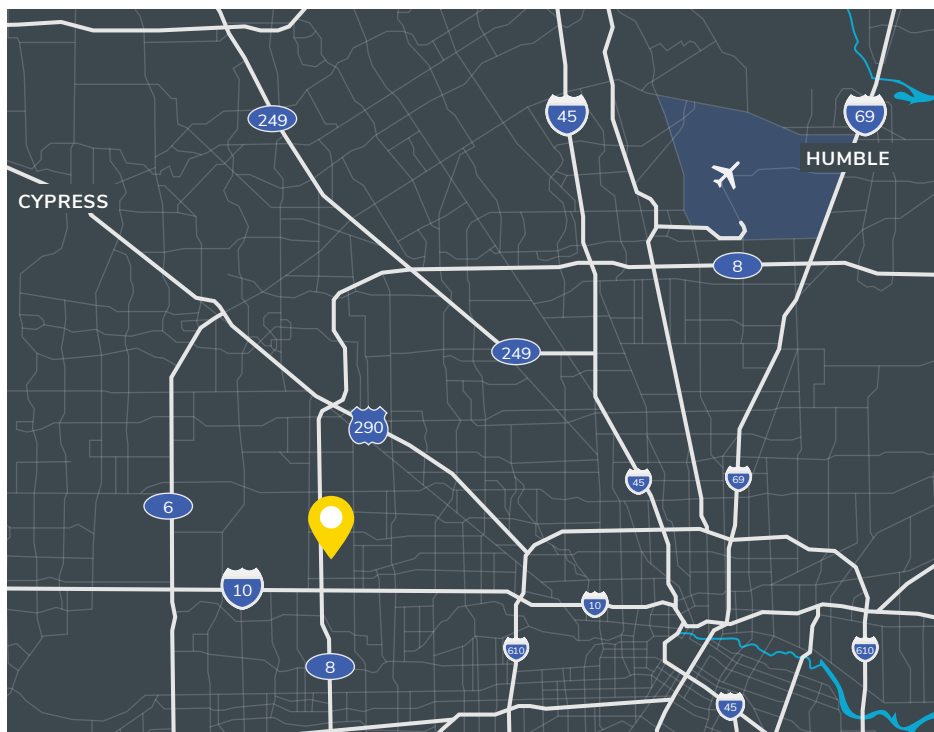

FOR LEASING INFORMATION, CONTACT:

Abraham Richardson

abraham.richardson@streamrealty.com

M. 713.364.2718

Jake Linderman

jacob.linderman@streamrealty.com

M. 832.332.1318

Zach Leger

zach.leger@streamrealty.com

M. 785.342.1917

STREAM

Megacenter[®]

MEMORIAL

1530 W. SAM HOUSTON PKWY. N. | HOUSTON, TX 77043

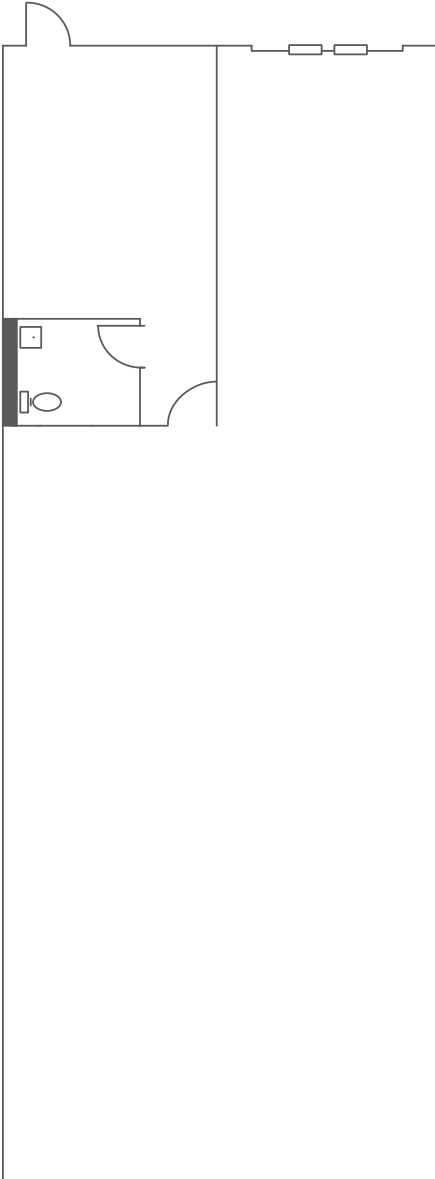

SUITE 111

- 2,400 SF Total
- 368 SF Office
- 24' Clear Height
- 1 Dock Door

Click or scan
QR code to view
virtual tour

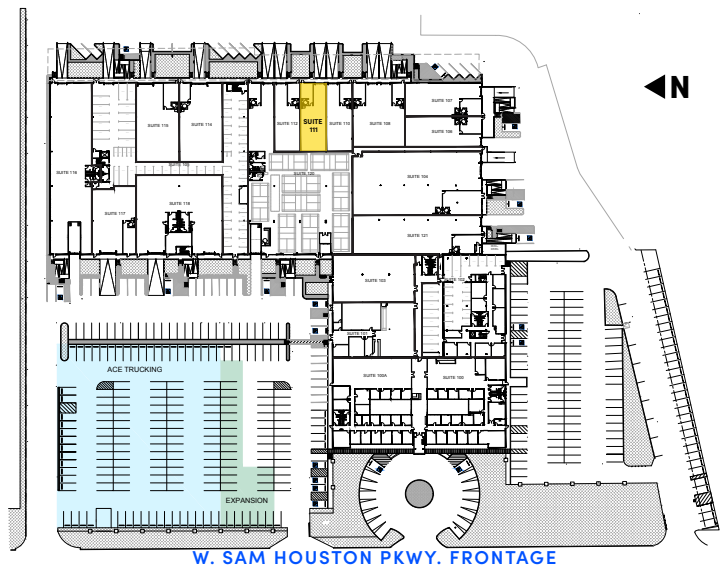

FOR LEASING INFORMATION, CONTACT:

Abraham Richardson

abraham.richardson@streamrealty.com

M. 713.364.2718

Jake Linderman

jacob.linderman@streamrealty.com

M. 832.332.1318

Zach Leger

zach.leger@streamrealty.com

M. 785.342.1917

STREAM[®]

Megacenter[®]

MEMORIAL

1530 W. SAM HOUSTON PKWY. N. | HOUSTON, TX 77043

SUITE 115

- 4,598 SF Total
- 540 SF Office
- 17' Clear Height
- 1 Ramp

Click or scan
QR code to view
virtual tour

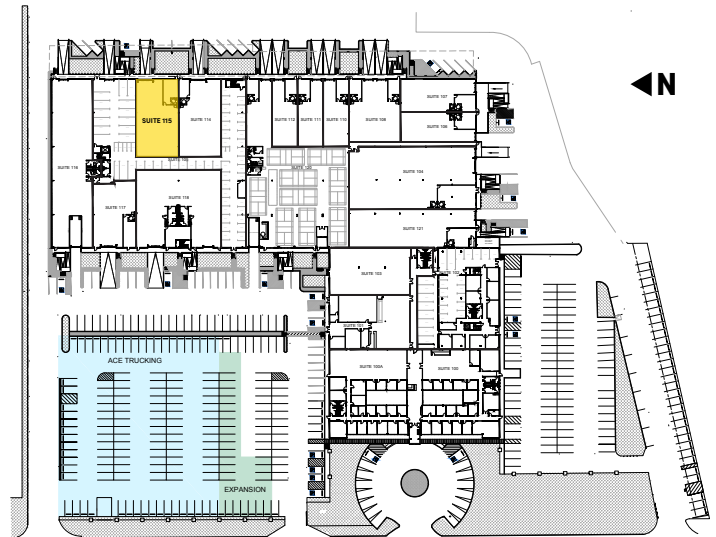
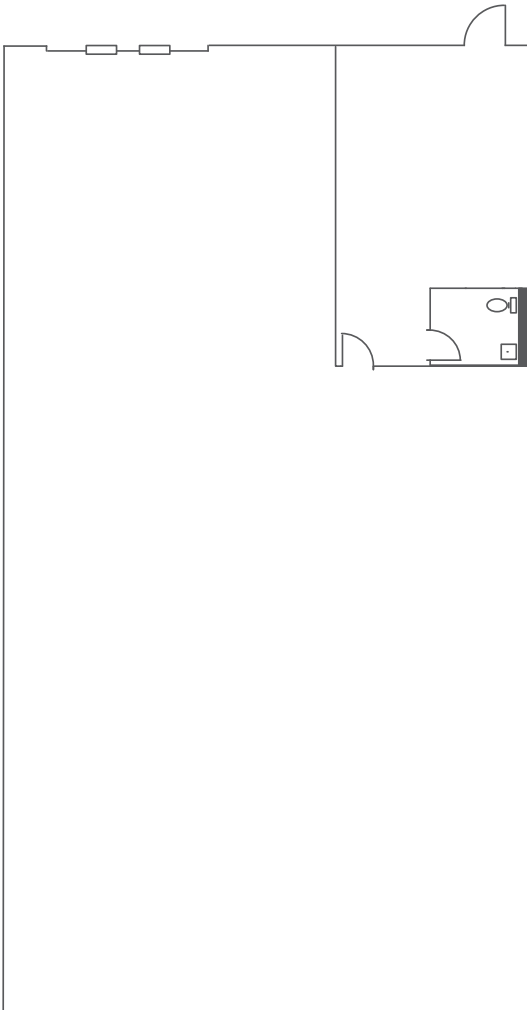

W. SAM HOUSTON PKWY. FRONTAGE

FOR LEASING INFORMATION, CONTACT:

Abraham Richardson

abraham.richardson@streamrealty.com

M. 713.364.2718

Jake Linderman

jacob.linderman@streamrealty.com

M. 832.332.1318

Zach Leger

zach.leger@streamrealty.com

M. 785.342.1917

STREAM[®]



1530 W. SAM HOUSTON PKWY. N. | HOUSTON, TX 77043

SUITE 117

- 3,974 SF Total
- 1,068 SF Office
- 17' Clear Height
- 1 Ramp

Click or scan QR code to view virtual tour

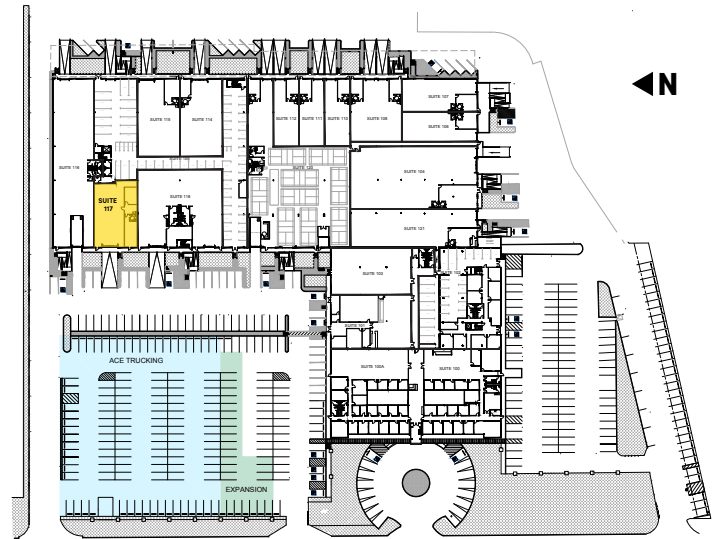
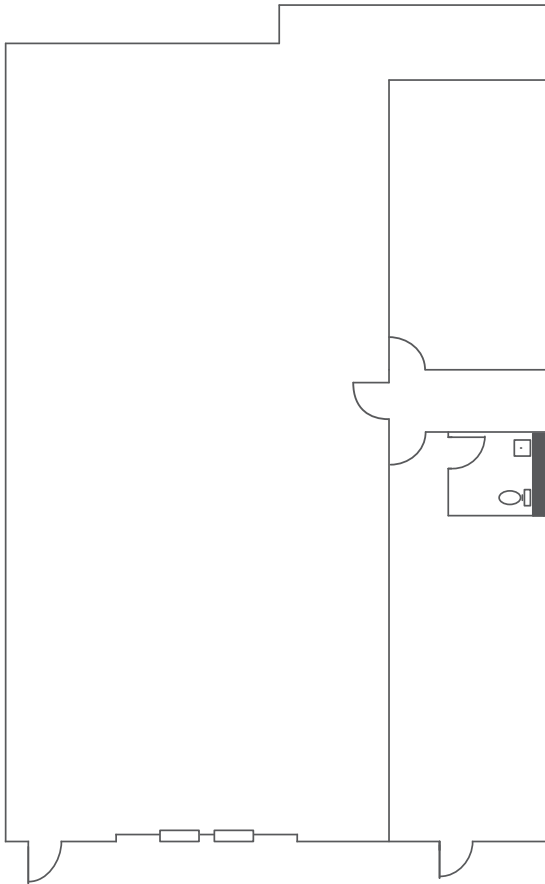

W. SAM HOUSTON PKWY. FRONTAGE

FOR LEASING INFORMATION, CONTACT:

Abraham Richardson

abraham.richardson@streamrealty.com

M. 713.364.2718

Jake Linderman

jacob.linderman@streamrealty.com

M. 832.332.1318

Zach Leger

zach.leger@streamrealty.com

M. 785.342.1917





Megacenter[®]

MEMORIAL

1530 W. SAM HOUSTON PKWY. N. | HOUSTON, TX 77043



FOR LEASING INFORMATION, CONTACT:

Abraham Richardson

abraham.richardson@streamrealty.com

M. 713.364.2718

Jake Linderman

jacob.linderman@streamrealty.com

M. 832.332.1318

Zach Leger

zach.leger@streamrealty.com

M. 785.342.1917

