

Ship To:
 Ericks Tacos
 12715 Nacogdoches Rd
 San Antonio, TX 78217
 2106323932

Sold To:
 Ericks Tacos
 12715 Nacogdoches Rd
 San Antonio, TX 78217

From:
 Mission Restaurant Sup - Showrm
 Valerie Velez
 1126 S. St. Marys
 San Antonio, TX 78210-1244
 (210)354-0690
 405-269-6639 2051 (Contact)

Job Reference Number: 18702

 ** Does not include Freight**

Item	Qty	Description	Sell	Sell Total
7	15 ea	TABLE, OUTDOOR  Bum Commercial Furniture USA Model No. CUBE 80 48052 NARDI Cube 80 Table, square, 31-1/2"W x 31-1/2"D x 29-1/2"H, outdoor/indoor, stackable, dining height, outdoor/indoor, fiberglass and resin dural-top, tubular aluminum powder coated legs, UV protected, non-slip adjustable feet, UV protected Dimensions 29.5(h) x 31.5(w) x 31.5(d)	\$200.00	\$3,000.00
	15 ea	Contact Bum Commercial Furniture for freight estimates from Buffalo, NY. Freight quote is valid for 14 days. Delivery is drop shipment only, no assistance included. Specify tailgate and/or delivery appointment in advance.		
	15 ea	3-year limited warranty (contact factory for details)		
	15 ea	Quick ship item		
	15 ea	48052.02 ANTHRACITE Anthracite for CUBE 80 48052 Weight: 390 lbs total		
			ITEM TOTAL:	\$3,000.00
2	15 ea	CHAIR Bum Commercial Furniture USA Model No. BIT SIDE 40328 NARDI Bit Stacking Side Chair, outdoor/indoor, perforated fiberglass and resin back and seat, UV protected, tubular fiberglass and resin frame, non-slip replaceable feet Dimensions 33(h) x 18.5(w) x 22(d)	\$89.00	\$1,335.00
	1 ea	Contact Bum Commercial Furniture for freight estimates from Buffalo, NY. Freight quote is valid for 14 days. Delivery is drop shipment only, no assistance included. Specify tailgate and/or delivery appointment in advance.		
	15 ea	3-year limited warranty (contact factory for details)		
	15 ea	Quick ship item		
	15 ea	02 ANTHRACITE (02) Anthracite Weight: 111 lbs total		
			ITEM TOTAL:	\$1,335.00

Item	Qty	Description	Sell	Sell Total
9	15 ea	CHAIR Bum Commercial Furniture USA Model No. BIT 40328 NARDI Bit Stacking Side Chair, outdoor/indoor, perforated fiberglass and resin back and seat, UV protected, tubular fiberglass and resin frame, non-slip replaceable feet Dimensions 33(h) x 23(w) x 18(d)	\$89.00	\$1,335.00
	1 ea	Contact Bum Commercial Furniture for freight estimates from Buffalo, NY. Freight quote is valid for 14 days. Delivery is drop shipment only, no assistance included. Specify tailgate and/or delivery appointment in advance.		
	15 ea	3-year limited warranty (contact factory for details)		
	15 ea	Quick ship item		
	15 ea	04 SALICE (04) Salice Weight: 115.5 lbs total		
			ITEM TOTAL:	\$1,335.00
9	15 ea	CHAIR Bum Commercial Furniture USA Model No. BIT 40328 NARDI Bit Stacking Side Chair, outdoor/indoor, perforated fiberglass and resin back and seat, UV protected, tubular fiberglass and resin frame, non-slip replaceable feet Dimensions 33(h) x 23(w) x 18(d)	\$89.00	\$1,335.00
	1 ea	Contact Bum Commercial Furniture for freight estimates from Buffalo, NY. Freight quote is valid for 14 days. Delivery is drop shipment only, no assistance included. Specify tailgate and/or delivery appointment in advance.		
	15 ea	3-year limited warranty (contact factory for details)		
	15 ea	Quick ship item		
	15 ea	56 SENAPE (56) Senape Weight: 115.5 lbs total		
			ITEM TOTAL:	\$1,335.00
9	15 ea	CHAIR Bum Commercial Furniture USA Model No. BIT 40328 NARDI Bit Stacking Side Chair, outdoor/indoor, perforated fiberglass and resin back and seat, UV protected, tubular fiberglass and resin frame, non-slip replaceable feet Dimensions 33(h) x 23(w) x 18(d)	\$89.00	\$1,335.00
	1 ea	Contact Bum Commercial Furniture for freight estimates from Buffalo, NY. Freight quote is valid for 14 days. Delivery is drop shipment only, no assistance included. Specify tailgate and/or delivery appointment in advance.		
	15 ea	3-year limited warranty (contact factory for details)		
	15 ea	Quick ship item		
	15 ea	75 CORALLO (75) Corallo Weight: 115.5 lbs total		
			ITEM TOTAL:	\$1,335.00

Merchandise	\$8,340.00
Tax 8.25%	\$688.05
Total	\$9,028.05

Due to the current volatility of manufacturer pricing, all prices are subject to potential price increase.

PAYMENT TERMS

50% Down and 50% prior to delivery.

CREDIT CARD PAYMENT

2% processing fees on orders \$10k or more.

RETURN POLICY

We will refund 100% of the purchase price of any **REGULARLY STOCKED** item purchased, provided the item is returned within **30 days** of purchase. The item(s) must be unused, in the manufacturer's packaging, and you must have a **RECEIPT**. Refunds exceeding \$200.00 will take 7-10 business working days to process. Purchases placed on a credit card will be issued a credit back to the same credit card. We will **NOT** issue credit for any item purchased over 30 days ago. Returned items will be subject to a 20% restocking charge. New equipment, accessories or parts that have been used, custom manufactured, or made-to-order will **NOT** be returned. Freight is **NON-REFUNDABLE**.

SPECIAL ORDERS

All Special Order, Made-to-Order, and Non-Stock items are **NON-RETURNABLE** and **NON-REFUNDABLE**.

STANDARD EXCLUSIONS

Plumbing and electrical hook-ups, including all indirect waste drains, back flow preventers, roof penetrations/resealing, curbs, supports, and pads are not included in this quote unless otherwise indicated.

SALES TAX

Any sales or use tax associated with the transaction(s) shall be paid by the Purchaser in full compliance with applicable law and may be added to the final invoice. Purchaser will provide the appropriate sales tax exemption certificate for the eligible items/services to be tax exempt.

ADDITIONAL FEES

Fees associated with freight, handling or processing may apply.

INSTALL/DELIVERY/DISPOSAL

MRS will deliver to front door, back door or dock. For **DELIVERY and INSTALL**, any packaging will be removed, plastic will be peeled (if desired), and accessories installed. **CONNECTION TO PLUMBING AND ELECTRICAL BY OTHERS. PRIOR** to installation, the old equipment must be emptied, disconnected from all utilities, and removed. MRS will not empty the equipment. Disconnection from gas lines and hardwiring to be done by others. There are (3) options for equipment removal: (1) **UNINSTALL AND DISPOSAL BY OTHERS** – equipment uninstalled and removed by others, (2) **DISPOSAL ONLY** - MRS will haul off already uninstalled equipment from premises for proper disposal. (3) **UNINSTALL AND DISPOSAL BY MRS** – MRS will uninstall equipment (disconnection from gas lines and hardwiring to be done by others), recover any refrigerant (if applicable) and haul off premises for proper disposal. For **DELIVERY ONLY**, item will remain crated or boxed and will **NOT** be taken inside the building.

Additional charges may apply if above installation requirements are not followed.

REGULATED BY THE TEXAS DEPARTMENT OF LICENSING AND REGULATION, P.O. Box 12157, Austin, TX 78711. (800) 803-9202, (512) 463-6599. www.tdlr.texas.gov Texas Refrigeration Licenses #TACLB42276C, #TACLB022617R, #TACLB020056R, #TACLB26723R

Acceptance: _____ Date: _____

Printed Name: _____

Cube

design Raffaello Galiotto

Ref. 480



YOUR OUTDOOR LIVING

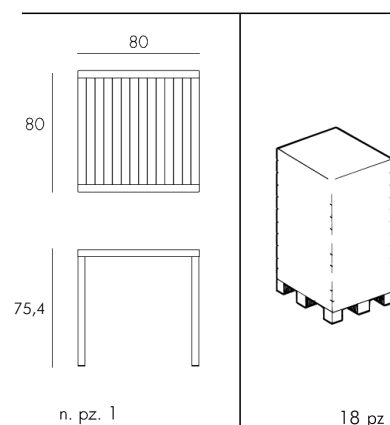

tested by:



ANTRACITE
verniciato antracite
48052.02.000



BIANCO
verniciato bianco
48053.00.000



CAFFE'
verniciato caffè
48057.05.000



TORTORA
verniciato tortora
48059.10.000

Tavolo impilabile 80x80 cm, piano DurelTOP in polipropilene trattato anti-UV e colorato in massa, gambe in alluminio verniciato con piedini regolabili.

Stackable table 80x80 cm, with DurelTOP in polypropylene with UV additives and is uniformly coloured, coated aluminium legs with adjustable height feet.



Table empilable 80x80 cm avec plateau DurelTOP en polypropylène traité anti-UV et coloré dans la masse, pieds en aluminium vernis avec vérins de réglage.

Stapelbarer Tisch 80x80 cm, mit DurelTOP Tischplatte aus UV-beständigem Polypropylen, voll durchgefärbt, Gestell aus epoxiertem Aluminium. Füße mit Höhenausgleich.

Mesa apilable 80x80 cm con tablero DurelTOP en polipropileno tratado anti UV y teñido en masa, patas en aluminio pintado con pies regulables.

Mesa empilhável 80x80 cm com tampo DurelTOP em polipropileno com tratamento anti-UV colorido na totalidade, pernas em alumínio pintado com pés reguláveis.

TABLES: DINING & BAR HEIGHT

Wood Textured Table 36"x59"   
 Wood textured polypropylene and fiberglass table, requires assembly.
 UV Protected with anti-static and antioxidant additives to resist dust and deterioration.
 Suitable for indoor and outdoor environments.



NVS-032-ANTRACITE

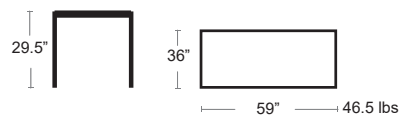

TABLES: DINING & BAR HEIGHT

Cube Rectangle    
 Resin and fiberglass slat top • Tubular resin and fiberglass legs • UV Protected

Cube 140 Dining Height

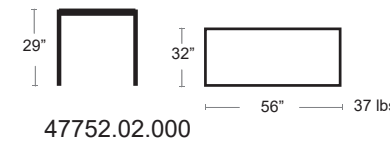

Cube 140 Bar Height

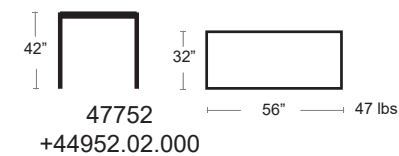

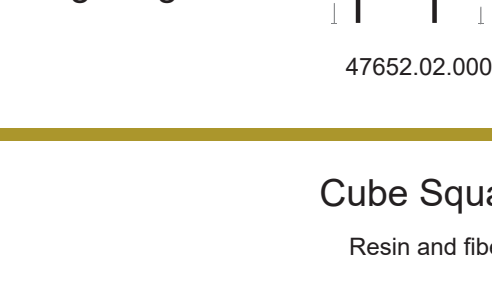
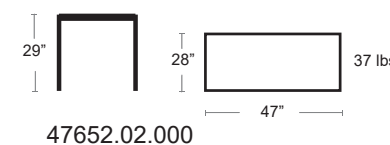

Cube 120 Dining Height

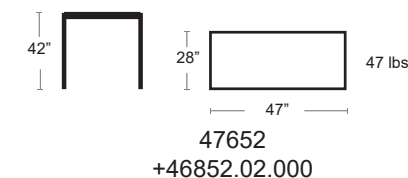

Cube 120 Bar Height



Wood Textured Table 35" Square   
 Wood textured polypropylene and fiberglass table, requires assembly.
 UV Protected with anti-static and antioxidant additives to resist dust and deterioration.
 Suitable for indoor and outdoor environments.



NVS-034-ANTRACITE

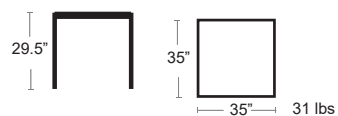

Cube Square    
 Resin and fiberglass slat top • Tubular resin and fiberglass legs • UV Protected

Cube 80 Dining Height

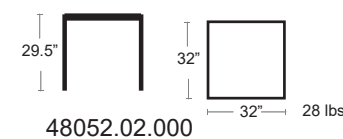

Cube 80 Bar Height

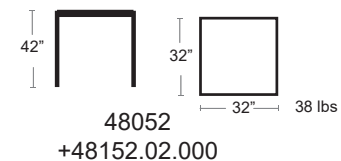

Cube 70 Dining Height

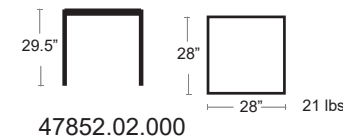

Cube 70 Bar Height

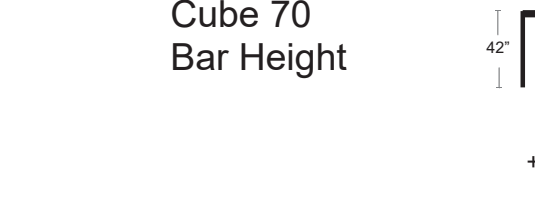
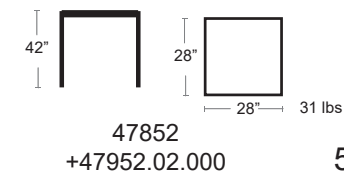

NARDI

YOUR OUTDOOR LIVING

BIT

design Raffaello Galiotto



Ref. 328

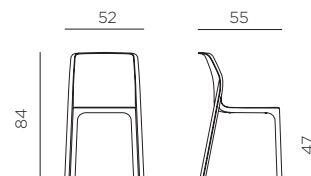

3,5

peso prodotto in kg
weight of product in kg

24

1,499 m³imballo con film - pz e volume in m³
shrink-wrapped packing -
pcs and volume in cbm

24 pz

pz su pallet
pcs on palletimpilabile
stackable**TESTED**prodotto testato a norma
product tested

IT Sedia monoblocco senza braccioli. Polipropilene fiberglass trattato anti-UV e colorato in massa. Finitura opaca. Dotata di piedini antiscivolo. Resina riciclabile.

EN Monobloc chair without armrest. Uniformly colored fiberglass polypropylene resins with UV additives. Matt finish. With non-slip feet. Recyclable resin.

FR Chaise monobloc sans accoudoirs. Polypropylène fiberglass traité anti-UV et coloré dans la masse. Effet mat. Avec patins anti-dérapants. Résine recyclable.

DE Monoblock Stuhl ohne Armlehne. UV-beständigem fiberglass-Polypropylen, voll durchgefärbt. Matt-Effekt. Mit rutschfesten Fußkappen. Recyclebarer Kunststoff.

ES Silla monoblocco sin brazos. Polipropileno fiberglass tratado anti-UV y teñido en masa. Efecto mate. Con tapones antideslizantes. Resina reciclable.

PT Cadeira monoblocco sem braços. Polipropileno fiberglass com tratamento anti-UV colorido na totalidade. Acabamento fosco. Com pés antiderrapantes. Resina reciclável.



BIANCO
40328.00.000



ANTRACITE
40328.02.000



SALICE
40328.04.000



TORTORA
40328.10.000



SENAPE
40328.56.000



CORALLO
40328.75.000

NARDI s.p.a.

36072 Chiampo (Vi) Italia - Via delle Stangà, 14 - Tel. +39 0444 422 100
www.nardioutdoor.com - info@nardioutdoor.com

made in italy

SIDE CHAIRS

Croisette Side Chair **SERRALUNGA CATAS**

Stackable monobloc chair made of fiberglass reinforced polypropylene. With its simple clean lines it is suitable for living/dining areas in contract applications. UV protected. Suitable for indoor and outdoor environments.



Arm Chair Pg.17



LIGHT GREEN
SL-CROISSETTE5635C



ANTRACITE
SL-CROISSETTE447C

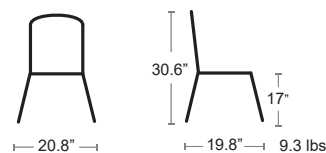

SIDE CHAIRS

Bit **NARDI CATAS**

Uniformly colored fiberglass polypropylene resins with UV additives • Matte finish • Non-slip feet • Recyclable resin.

Net Arm Chair Pg.19, Bar Stool Pg.42, Lounge Pg.86-89



SENAPE
40328.56.000



SALICE
40328.04.000



CORALLO
40328.75.000



ANTRACITE
40328.02.000

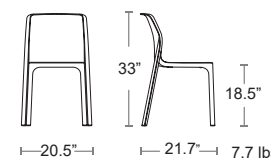

TORTORA
40328.10.000



BIANCO
40328.00.000

Doga Bistrot **NARDI CATAS**

Uniformly colored fiberglass polypropylene resins with UV additives • Matte finish • Non-slip feet • Recyclable resin

Arm Chair Pg.20, Lounge Pg.89/90



BIANCO
40255.00.000



PERA
40255.18.000



MARSALA
40255.21.000



AGAVE
40255.16.000



ANTRACITE
40255.02.000

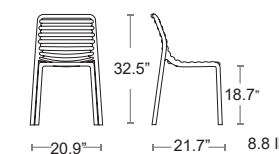

Africa **VONDOM**

Tubular resin and fiberglass frame • Solid resin and fiberglass seat and back • UV Protected

Arm Chair Pg.17, Bar Stool Pg.41



WHITE
65036-WHITE



BLACK
65036-BLACK

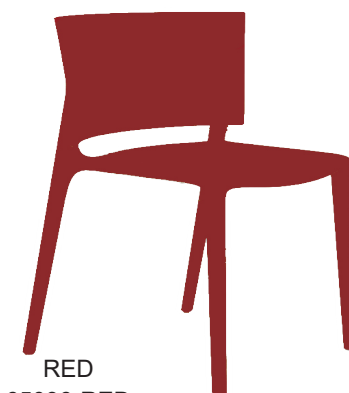

RED
65036-RED

