



FLEX SPACE FOR LEASE

8424-8430 & 8442-8446 LEE HIGHWAY

FAIRFAX, VA 22031



8424-8430 LEE HWY

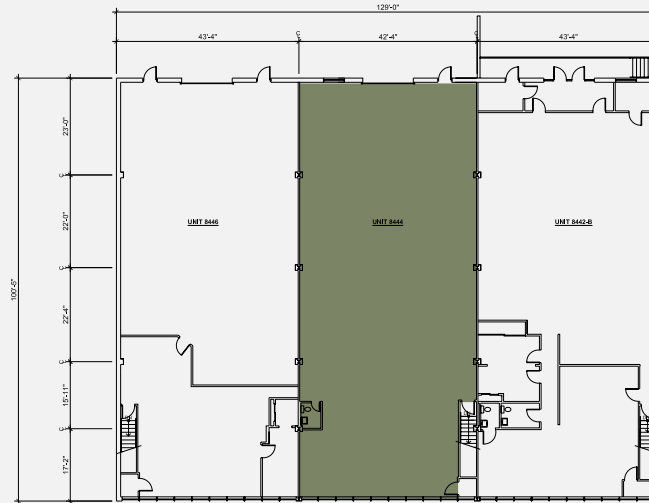

FLOOR PLANS

SITE PLAN

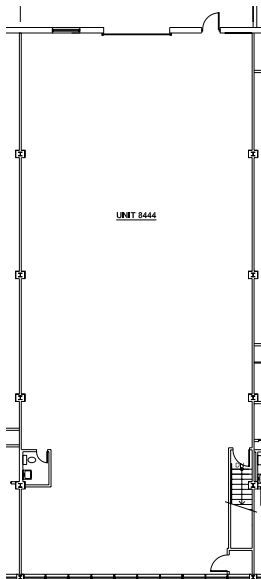

SUITE 8444:	
Suite	Suite 8444
Available SF	4,300 SF
Clear Height	16'
Loading	One Drive-in

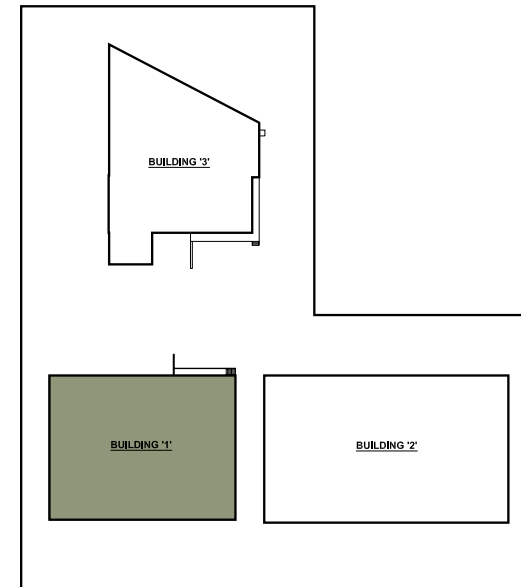

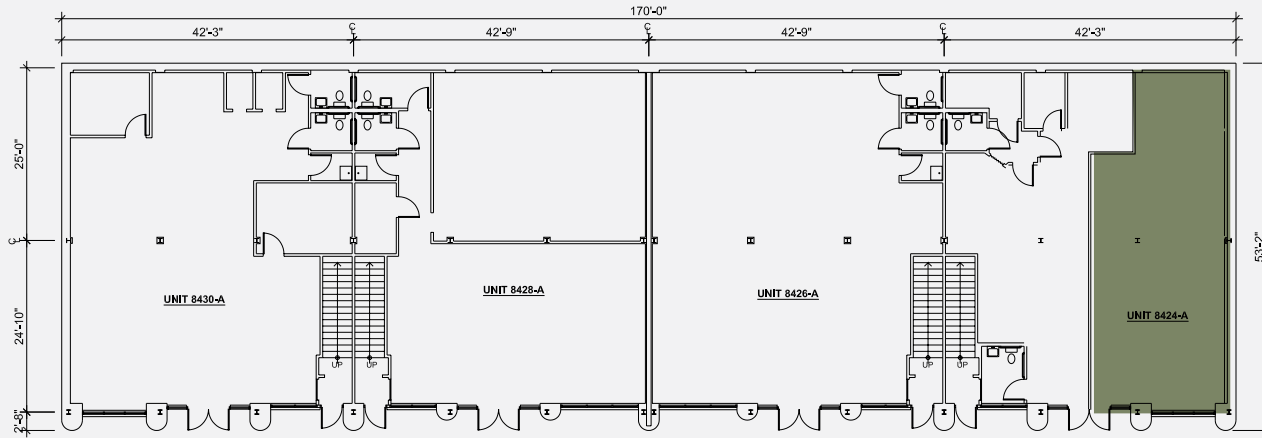

FLOOR PLANS

SITE PLAN

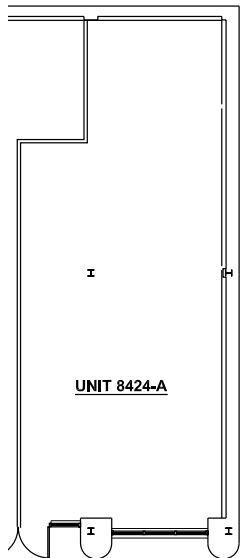

SUITE 8426A:	
Suite	Suite 8424A
Available SF	1,475 SF
Condition	Shell Condition

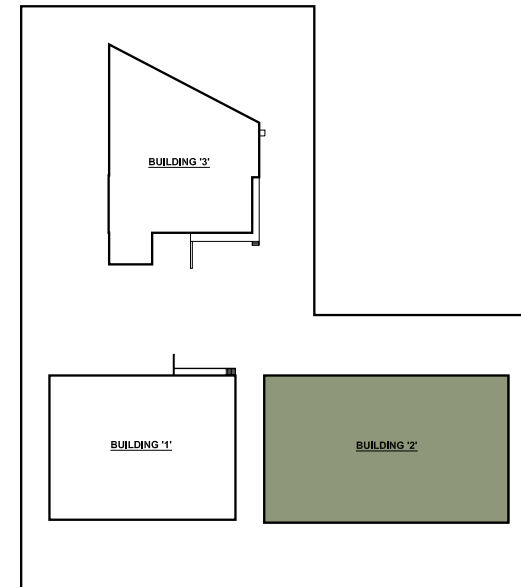

AMENITIES MAP

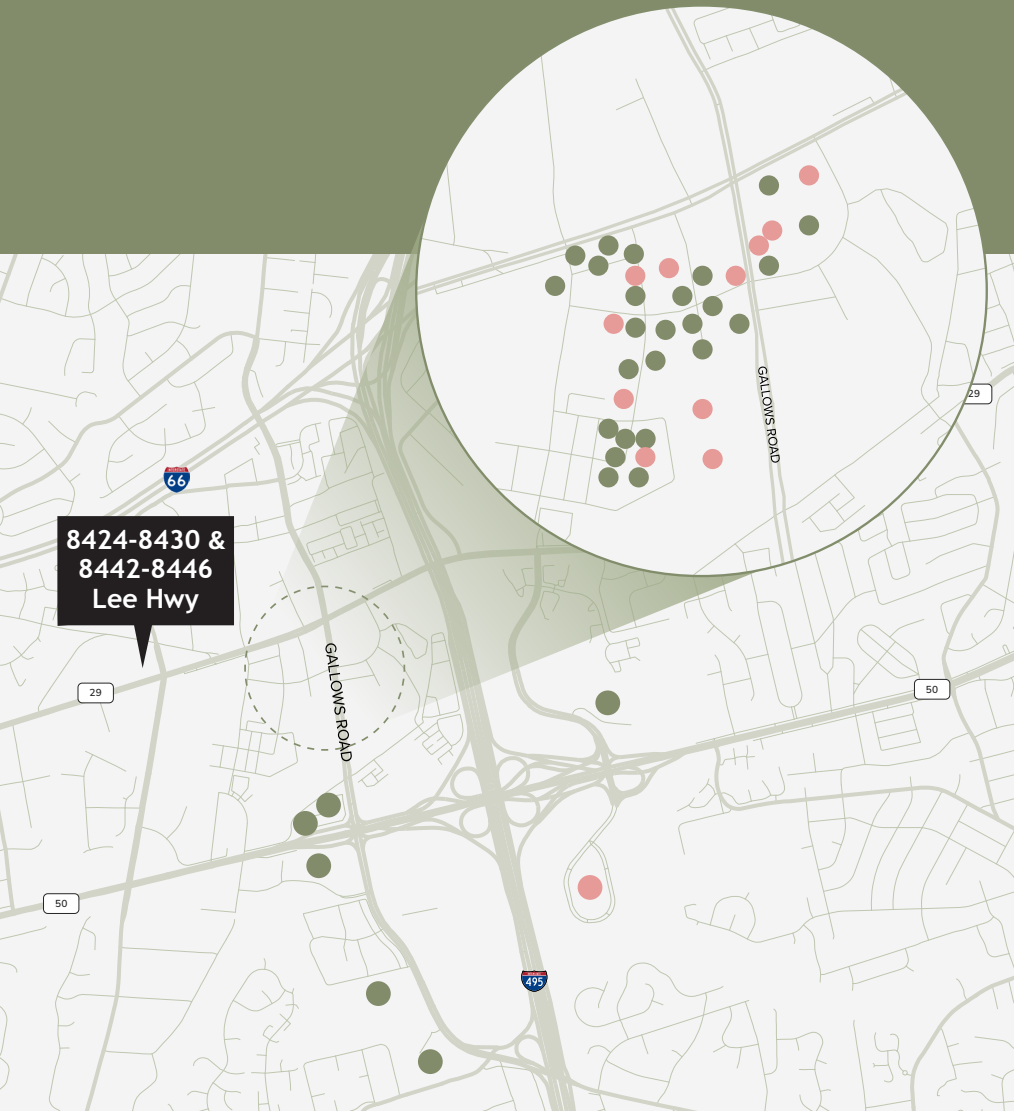

● RESTAURANTS :

- JINYA Ramen
- Ted Bulletin
- Alta Strada
- Kirby Club
- Chipotle
- Panera Bread
- Shake Shack
- Bartaco
- Macmillan Whiskey Room
- Colada by Bloomies
- Gyu Shige
- Urban Hot Pot
- Pupatella
- Sisters Thai
- Our Mom Eugenia
- Nando's PERI-PERI
- True Kitchen
- Sweetgreen
- Pastry Xpo Cafe
- AKB, A Hotel Bar
- Le Pain Quotidien
- B Side
- MOM's Bakery
- Caboose Commons
- Arby's
- Raouche
- Silver Diner
- Panera Bread
- Woodburn Cafe
- Sophia's Cafe
- Guapo's Tex-Mex
- Sweetwater Tavern
- Puzukan Tan Korean Grill
- 2941 Restaurant

● OTHER AMENITIES :

- Marriot
- Target
- H Mart
- Lidl
- Wells Fargo
- LA Fitness
- Bloomie's
- Solidcore
- Gold's Gym
- Musicbox Karaoke
- Paper Source
- Muse Paintbar



REGIONAL MAP

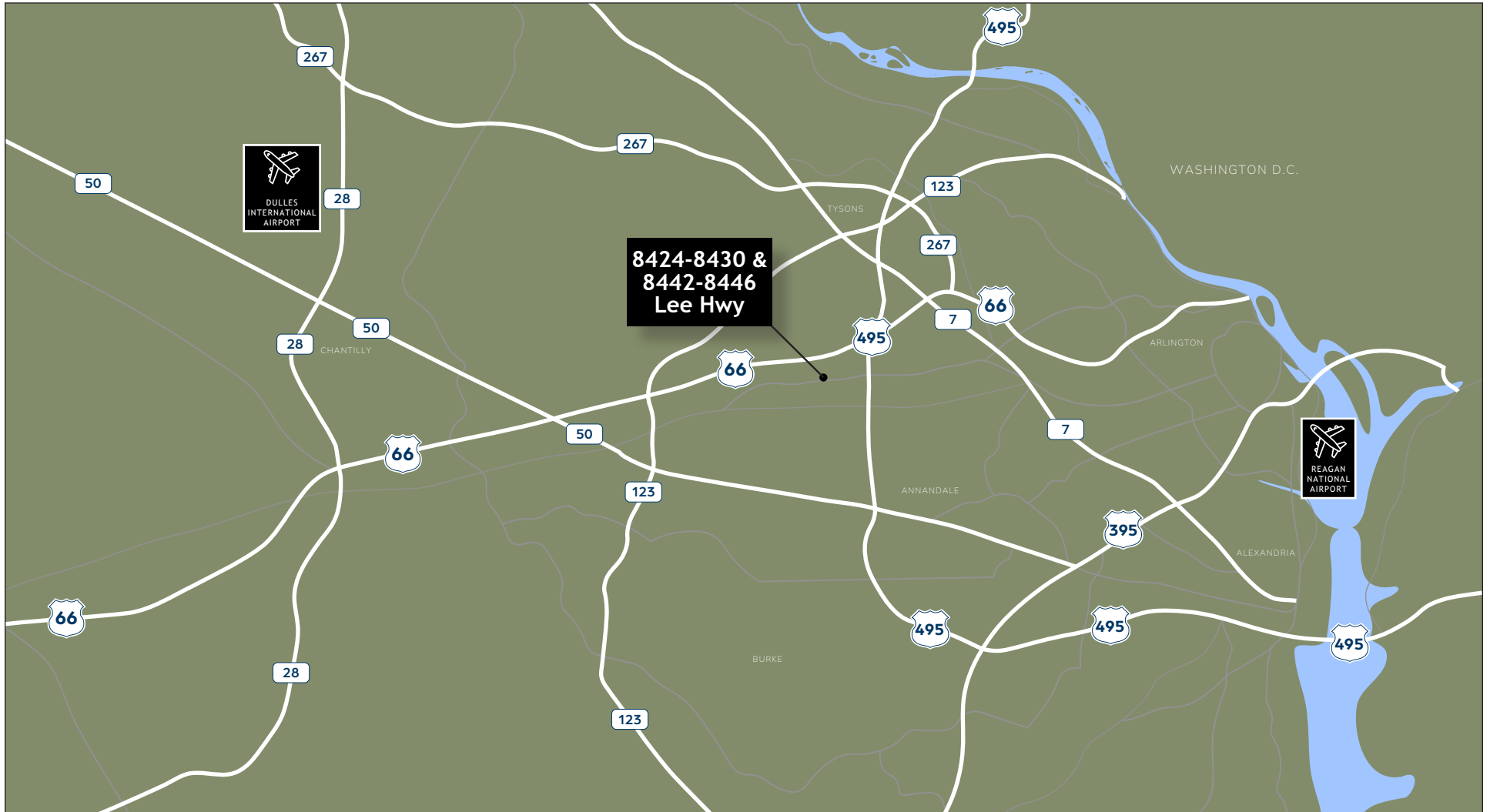

LOCATION & TRAVEL TIMES

MOSAIC	4 MINUTES (<0.5 MI)	DCA	22 MINUTES (13.1 MI)
I-66	6 MINUTES (2 MI)	D.C.	24 MINUTES (14.2 MI)
I-495	7 MINUTES (4.2 MI)	IAD	28 MINUTES (20.4 MI)
TYSONS	10 MINUTES (5 MI)		
I-95	12 MINUTES (13 MI)		

8424-8430 | 8442-8446

LEE HIGHWAY, FAIRFAX, VA 22031

ANDREW HASSETT

703.705.2921

andrew.hassett@streamrealty.com

ANABELLE GARTLAND

703.574.3621

anabelle.gartland@streamrealty.com



7900 Tysons One Place
Suite 280
McLean, VA 22102

Copyright © 2024 Stream Realty Partners, All rights reserved.

The information contained herein was obtained from sources believed reliable; however, Stream Realty Partners, L.P. make no guarantees, warranties, or representations as to the completeness or accuracy thereof. The presentation of this property is submitted subject to errors, change of price, or conditions, prior sale or lease, or withdrawal without notice.