

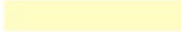

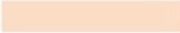

Nexus Building

6325 Ardrey Kell Road
Suite 350
Charlotte, NC 28277

OVERALL FLOORPLAN

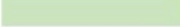

- | | | | |
|---|-----------------------------|---|---------------|
|  | RECEPTION |  | TRAINING ROOM |
|  | PRIVATE OFFICES/TOUCH DOWNS |  | BREAK ROOM |
|  | WORKSTATIONS |  | LOUNGE AREA |
|  | CONFERENCE ROOM | | |

RECEPTION



RECEPTION
21 X 19

QTY: 1
10 WEEK LEAD TIME



RD.01

MANUFACTURER
KNOLL
REFP PROFILES

DIMENSIONS
120"W x 30"D

DETAILS

- 30"D x 84"W FRONT DESK W/ 24"D x 30"W RETURN
- 10"D x 84"W TRANSACTION TOP
- 30"D x 36"W FIXED WORK SURFACE
- MOBILE BF PEDESTAL & 24"D x 36"W 2-DRAWER LATERAL FILE
- FROSTED GLASS FRONT PANEL
- 14"H x 84"W FABRIC TACKBOARD



LAMINATE
CLASSIC OAK (143)



GLASS FRONT
WHITE
BACK PAINTED



LAMINATE
BRIGHT WHITE (118)



TACKBOARD FABRIC
SKYLARK
SILVERSPOON (W17189)

QTY: 1
14 WEEK LEAD TIME



CH.02

MANUFACTURER
KNOLL
GENERATION

DETAILS

- MID FLEX BACK
- WEIGHT SENSING TILT MECHANISM
- HEIGHT ADJUSTABLE ARMS
- BLACK PLASTIC BASE
- SOFT CASTERS FOR VINYL FLOORING



FLEX BACK
ONYX



SEAT UPHOLSTERY
STORM

(20) PRIVATE OFFICES – TYPICAL #1

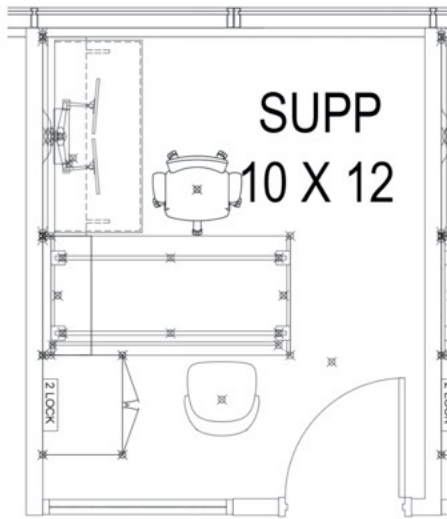

QTY: 20
10 WEEK LEAD TIME



PO.01

MANUFACTURER
KNOLL
REFF PROFILES

DIMENSIONS
8 x 6 FOOTPRINT

DETAILS

- 36"D x 72"W FIXED DESK w/ 30"D x 60"W FREESTANDING C-LEG HEIGHT ADJUSTABLE RETURN
- 30"W x 24"D x 86"H 2-DRAWER LATERAL FILE TOWER w/ 2-DOOR UPPER STORAGE
- (3) 14"D x 36"W L-SHELVES
- (2) 30"W x 62"H WALL MOUNTED MARKERBOARD
- DUAL MONITOR ARM, CABLE BASKET WIRE MANAEGMENT, & POWER STRIP



LAMINATE
CLASSIC OAK (143)



PAINT
BRIGHT WHITE (118)

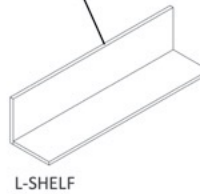

QTY: 25
14 WEEK LEAD TIME



CH.01

MANUFACTURER
KNOLL
LIFE

DETAILS

- MID MESH BACK w/ LUMBAR SUPPORT
- WEIGHT SENSING TILT MECHANISM
- HEIGHT ADJUSTABLE ARMS
- SEAT DEPTH ADJUSTMENT
- PAINTED MATTE ALUMINUM BASE
- HARD CASTERS FOR CARPET



MESH BACK
BLACKOUT



SEAT UPHOLSTERY
DARK GREY KNIT

QTY: 25
6 WEEK LEAD TIME



CH.03

MANUFACTURER
KNOLL
REMIX

DETAILS

- WOOD FRAME w/ ARMS
- GLIDE BASE



SEAT UPHOLSTERY
KNOLL
SUMMIT
SKYLINE (K20206)



BASE
BLACK

RECEPTION



QTY: 3
14 WEEK LEAD TIME



CH.05

MANUFACTURER
STYLEX
COVE

DIMENSIONS
36"W x 30.5"D x 30"H

- DETAILS**
- 4-LEG METAL BASE
 - AUTO RETURN SWIVEL BASE



SEAT UPHOLSTERY
KNOLL
SUMMIT
SKYLINE (K20206)



BASE
MATTE BLACK

QTY: 1
14 WEEK LEAD TIME



TB.01

MANUFACTURER
OFS
WYRE OCCASIONAL TABLE

DIMENSIONS
20"D x 22"H

- DETAILS**
- POWDER COATED METAL FRAME



LAMINATE TOP
DESERT (DS2)



BASE
POLAR

(3) PRIVATE OFFICES – TYPICAL #2

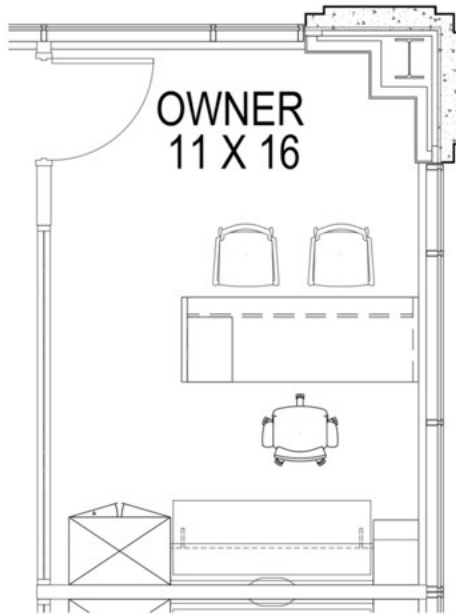

QTY: 4
10 WEEK LEAD TIME



PO.02

MANUFACTURER
KNOLL
REFF PROFILES

DIMENSIONS
8 x 8'-6" FOOTPRINT

- DETAILS**
- 30"D x 84"W FIXED DESK w/ 24"D x 72"W HEIGHT ADJUSTABLE REAR WALL HUNG DESK
 - 36"W x 24"D x 86"H STORAGE TOWER W/ FF PEDESTAL, SINGLE DOOR CABINET & WARDROBE
 - 18"W ABOVE SURFACE OPEN STORAGE CABINET W/ FF PEDESTAL
 - 72"W x 62"H WALL MOUNTED MARKERBOARD
 - DUAL MONITOR ARM, CABLE BASKET WIRE MANAEGMENT, & POWER STRIP



LAMINATE
CLASSIC OAK (143)



LAMINATE
BRIGHT WHITE (118)

QTY: 4
14 WEEK LEAD TIME



CH.01

MANUFACTURER
KNOLL
LIFE

- DETAILS**
- MID MESH BACK w/ LUMBAR SUPPORT
 - WEIGHT SENSING TILT MECHANISM
 - HEIGHT ADJUSTABLE ARMS
 - SEAT DEPTH ADJUSTMENT
 - PAINTED MATTE ALUMINUM BASE
 - HARD CASTERS FOR CARPET

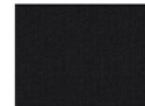

MESH BACK
BLACKOUT



SEAT UPHOLSTERY
DARK GREY KNIT

QTY: 8
8 WEEK LEAD TIME



CH.04

MANUFACTURER
KNOLL
KRUSIN

- DETAILS**
- WOOD FRAME w/ ARMS

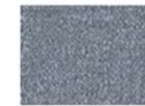

SEAT UPHOLSTERY
KNOLL
SUMMIT
SKYLINE (K20206)



WOOD FRAME
EBONIZED OAK

(5) PRIVATE OFFICES – TYPICAL #3

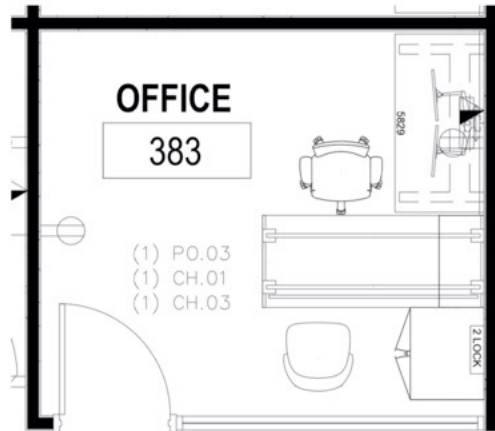

QTY: 5
10 WEEK LEAD TIME



PO.03

MANUFACTURER
KNOLL
REFR. PROFILES

DIMENSIONS
7'-6" x 6 FOOTPRINT

DETAILS

- 30"D x 72"W FIXED DESK w/ 30"D x 60"W FREESTANDING C-LEG HEIGHT ADJUSTABLE RETURN
- 30"W x 24"D x 86"H 2-DRAWER LATERAL FILE TOWER w/ 2-DOOR UPPER STORAGE
- (3) 14"D x 30"W L-SHELVES
- (2) 30"W x 62"H WALL MOUNTED MARKERBOARD
- DUAL MONITOR ARM, CABLE BASKET WIRE MANAEGMENT, & POWER STRIP



LAMINATE
CLASSIC OAK (143)



PAINT
BRIGHT WHITE (118)

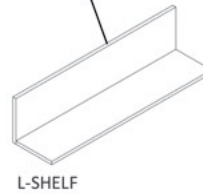

L-SHELF

QTY: 25
14 WEEK LEAD TIME



CH.01

MANUFACTURER
KNOLL
LIFE

DETAILS

- MID MESH BACK w/ LUMBAR SUPPORT
- WEIGHT SENSING TILT MECHANISM
- HEIGHT ADJUSTABLE ARMS
- SEAT DEPTH ADJUSTMENT
- PAINTED MATTE ALUMINUM BASE
- HARD CASTERS FOR CARPET



MESH BACK
BLACKOUT



SEAT UPHOLSTERY
DARK GREY KNIT

QTY: 25
6 WEEK LEAD TIME



CH.03

MANUFACTURER
KNOLL
REMIX

DETAILS

- WOOD FRAME w/ ARMS
- GLIDE BASE

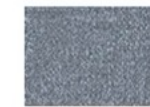

SEAT UPHOLSTERY
KNOLL
SUMMIT
SKYLINE (K20206)

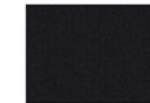

BASE
BLACK

TOUCH DOWN

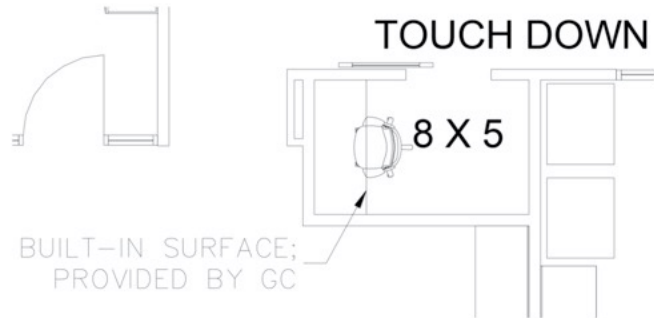

QTY: 1
14 WEEK LEAD TIME



CH.02

MANUFACTURER
KNOLL
GENERATION

DETAILS

- MID FLEX BACK
- WEIGHT SENSING TILT MECHANISM
- HEIGHT ADJUSTABLE ARMS
- BLACK PLASTIC BASE
- HARD CASTERS FOR CARPET



FLEX BACK
ONYX

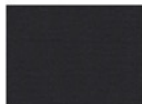

SEAT UPHOLSTERY
STORM

(9) 6 X 8 WORKSTATIONS

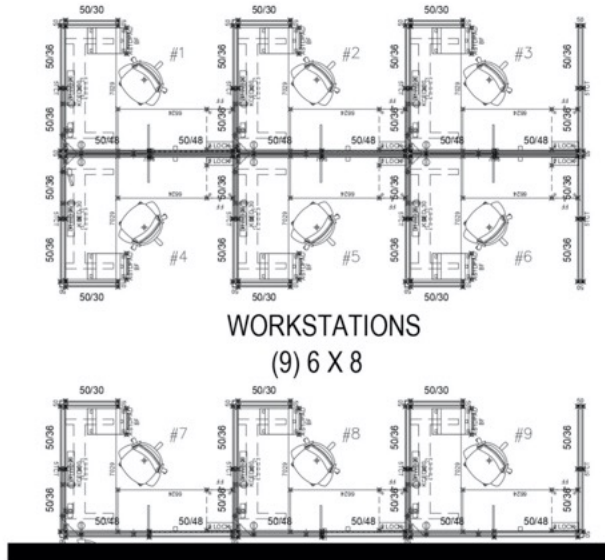

QTY: 9
8 WEEK LEAD TIME



WS.01

MANUFACTURER
KNOLL
DIVIDENDS HORIZON

DIMENSIONS
50" H FABRIC PANELS

DETAILS

- 30"D x 72"W HEIGHT ADJUSTABLE SURFACE w/ 24"D x 66"W FIXED RETURN SURFACE
- 7"H GLASS ALONG CENTER SPINE (NOT INCLUDED ON STATIONS 7-9)
- FF PEDESTAL & MOBILE BF PEDESTAL w/ CUSHION TOP
- DESKTOP MOUNTED POWER MODULE, WIRE BASKET CABLE MANAGEMENT & WIRE MANAGER



POWER MODULE



LAMINATE
CLASSIC OAK (143)



PAINT
BRIGHT WHITE (118)



PANEL FABRIC
SKYLARK
SILVERSPoon (W17189)



PED CUSHION
SUMMIT
SKYLINE (K20206)

QTY: 9
14 WEEK LEAD TIME



CH.02

MANUFACTURER
KNOLL
GENERATION

DETAILS

- MID FLEX BACK
- WEIGHT SENSING TILT MECHANISM
- HEIGHT ADJUSTABLE ARMS
- BLACK PLASTIC BASE
- HARD CASTERS FOR CARPET



FLEX BACK
ONYX

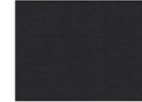

SEAT UPHOLSTERY
STORM

LARGE CONFERENCE ROOM

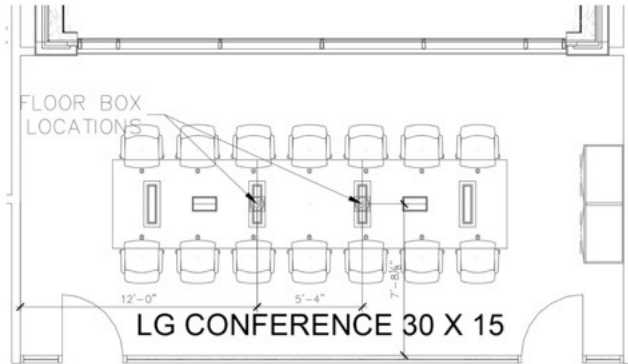

QTY: 1
8 WEEK LEAD TIME



TB.02

MANUFACTURER
ENWORK
FOUNDATION

DIMENSIONS
54"D x 240"W

DETAILS

- KNIFE EDGE BACK PAINTED GLASS TOP
- (4) BASES w/ ALUMINUM TRIM & (2) CENTER BASES w/ ACCESS DOORS
- (2) POWER & DATA UNITS (6 POWER, 1 HDMI & 1 RJ45 CAT6 PER UNIT)



ALUMINUM TRIM



POWER UNIT



GLASS TOP
FROSTED WHITE



LAMINATE BASE
VERANDA TEAK

QTY: 14
8 WEEK LEAD TIME



CH.06

MANUFACTURER
KRUG
C5

DETAILS

- FULLY UPHOLSTERED MID BACK
- GAS PNEUMATIC LIFT
- POLISHED ALUMINUM ARMS & BASE

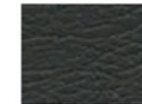

UPHOLSTERY
ULTRALEATHER
RAVEN WING (291-5607)

LARGE CONFERENCE ROOM

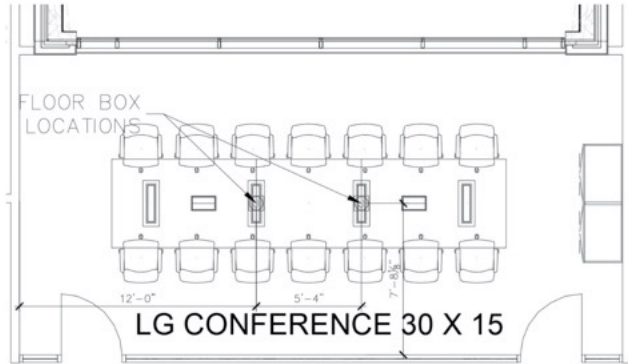

QTY: 1
8 WEEK LEAD TIME



ST.01

MANUFACTURER
ENWORK
FOUNDATION

DIMENSIONS
24"D x 72"W x 36"H

DETAILS

- (2) LOWER 2-DOOR CABINETS
- (4) UPPER DRAWERS
- BAR PULLS



LAMINATE
VERANDA TEAK

TRAINING ROOM

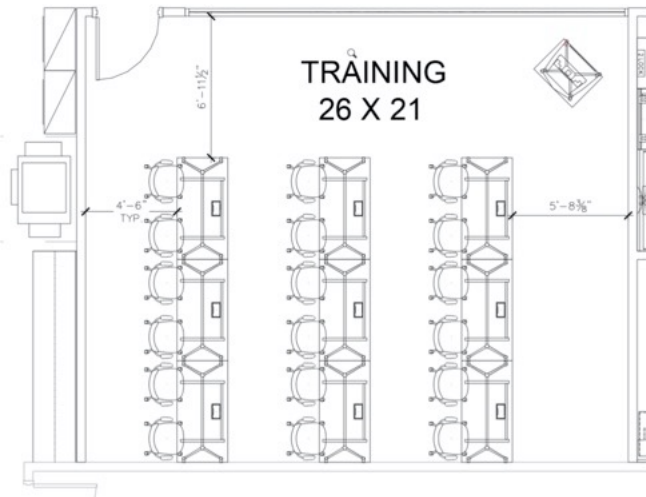

QTY: 9
8 WEEK LEAD TIME



TB.05

MANUFACTURER
ENWORK
ZORI

DIMENSIONS
30"D x 60" W x 29"H

DETAILS

- CASTER BASE
- CENTER POWER UNIT w/ 2 DUPLEXES & 2 USBs PER UNIT
- DAISY CHAINED
- ROUTING HOLE ALLOWS CABLE MANAGEMENT THROUGH LEG COLUMN



POWER UNIT



LAMINATE
VERANDA TEAK



PAINT
ARCTIC WHITE

QTY: 18
8 WEEK LEAD TIME



CH.08

MANUFACTURER
KNOLL
REMIX FULLY UPHOLSTERED

DETAILS

- NET FLEX BACK
- HEIGHT ADJUSTABLE ARMS
- BLACK PLASTIC BASE W/ HARD CASTERS FOR CARPET



NET FLEX BACK
STORM



UPHOLSTERY
DELITE
CHARCOAL

QTY: 1
8 WEEK LEAD TIME



ST.02

MANUFACTURER
ENWORK
ZORI

DIMENSIONS
24"D x 38" W x 42"H

DETAILS

- PNEUMATIC HEIGHT w/ CASTER BASE
- FIXED MODESTY BACK PANEL



LAMINATE
VERANDA TEAK



PAINT
ARCTIC WHITE

BREAK ROOM

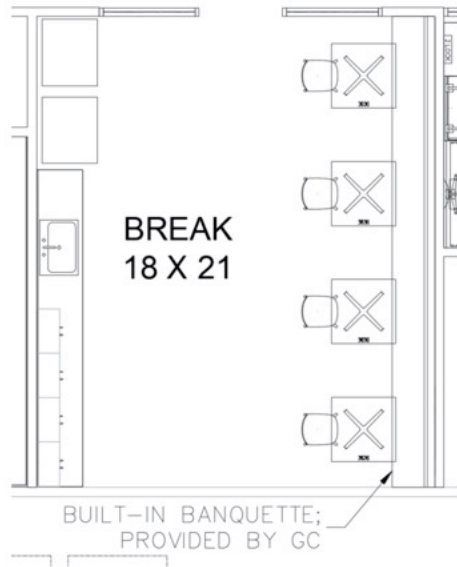

QTY: 4
8 WEEK LEAD TIME



TB.06

MANUFACTURER
KNOLL
DIVIDENDS HORIZON

DIMENSIONS
36" Sq. x 29"H

DETAILS

- LAMINATE TOP
- PAINTED METAL BASE



LAMINATE
CLASSIC OAK (143)



PAINT
BRIGHT WHITE (118)

QTY: 4
6 WEEK LEAD TIME



CH.10

MANUFACTURER
MUUTO
VISU SIDE CHAIR

DETAILS

- 4-LEG WOOD BASE



WOOD FINISH
GREY

LOUNGE AREA

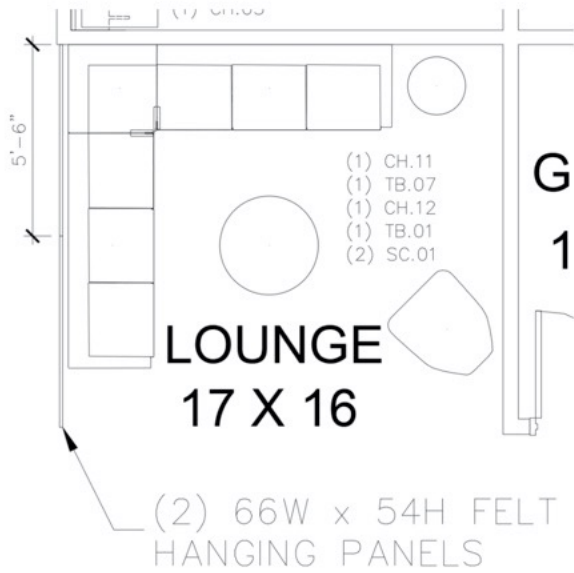

QTY: 1
14 WEEK LEAD TIME



CH.11

MANUFACTURER
OFS
ROWEN

DETAILS

- L-SHAPED SOFA w/ CORNER UNIT
- POLISHED CHROME LEGS
- SINGLE UPHOLSTERY ONLY



BASE
POLISHED ALUMINUM



UPHOLSTERY
KNOLL
SUMMIT
BOULDER (K20210)

QTY: 1
14 WEEK LEAD TIME



TB.07

MANUFACTURER
OFS
WYRE OCCASIONAL TABLE

DIMENSIONS
36"D x 17"H

DETAILS

- POWDER COATED METAL FRAME



LAMINATE TOP
DESERT (DS2)



BASE
POLAR

QTY: 1
8 WEEK LEAD TIME



CH.12

MANUFACTURER
VIA SEATING
METEOR

DETAILS

- CHROME BASE
- SWIVEL AUTO RETURN



BASE
POLISHED ALUMINUM



SEAT UPHOLSTERY
KNOLL
SUMMIT
SKYLINE (K20206)

LOUNGE AREA

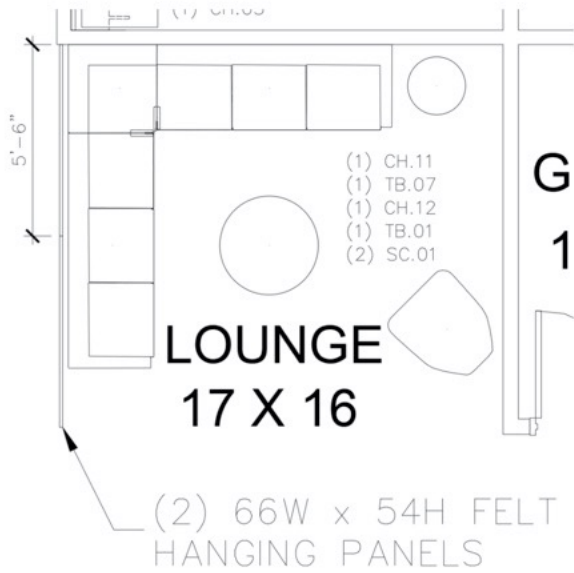

QTY: 1
14 WEEK LEAD TIME



CH.11

MANUFACTURER
OFS
ROWEN

DETAILS

- L-SHAPED SOFA w/ CORNER UNIT
- POLISHED CHROME LEGS
- SINGLE UPHOLSTERY ONLY



BASE
POLISHED ALUMINUM



UPHOLSTERY
KNOLL
SUMMIT
BOULDER (K20210)

QTY: 1
14 WEEK LEAD TIME



TB.07

MANUFACTURER
OFS
WYRE OCCASIONAL TABLE

DIMENSIONS
36"D x 17"H

DETAILS

- POWDER COATED METAL FRAME



LAMINATE TOP
DESERT (DS2)



BASE
POLAR

QTY: 1
8 WEEK LEAD TIME



CH.12

MANUFACTURER
VIA SEATING
METEOR

DETAILS

- CHROME BASE
- SWIVEL AUTO RETURN



BASE
POLISHED ALUMINUM



SEAT UPHOLSTERY
KNOLL
SUMMIT
SKYLINE (K20206)

LOUNGE AREA

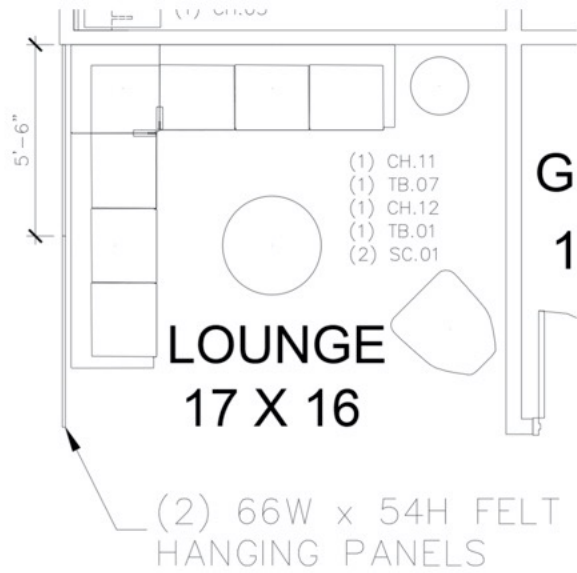

QTY: 1
14 WEEK LEAD TIME



TB.01

MANUFACTURER
OFS
WYRE OCCASIONAL TABLE

DIMENSIONS
20"D x 22"H

DETAILS
• POWDER COATED METAL FRAME



LAMINATE TOP
DESERT (DS2)



BASE
POLAR

QTY: 2
10 WEEK LEAD TIME



SC.01

MANUFACTURER
FILZ FELT
ARROW HANGING PANELS

DIMENSIONS
66"W x 54"H

DETAILS
• FELT PANEL
• STATIONARY CHANNEL
• CABLE SUSPENDED SUPPORTED BY ACT GRID CLIP
• VELCRO ATTACHMENT



FELT
H'BLAU (286)



THANK YOU.