



Merrick Park

FROM 1,020 SF - 6,000 SF • FLEX FOR LEASE
930-940 N Belt Line & 1004-1032 Luke St, Irving, Texas 75061

Availability:

- Suite 111 – 1,026 SF
- Suite 119 – 3,000 SF
- Suite 120/122 – 6,000 SF
- Suite 137 – 3,000 SF
- Suite 140 – 3,000 SF

Property Highlights:

- 13' clear height
- Grade level and dock level doors
- 100% air-conditioned spaces available
- Move-in ready spaces
- Close proximity to DFW Airport
- Easy access from HWY 183 & 161/ I-30 & loop 12

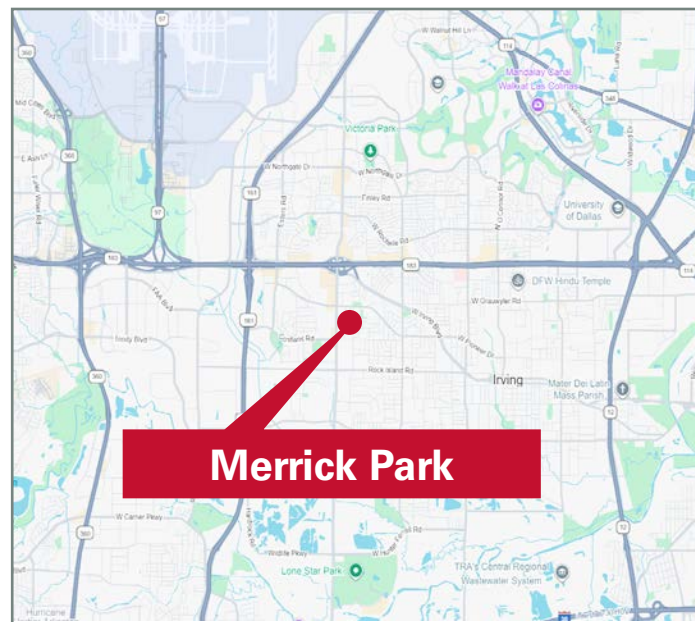

Leased by:



Chris Kennedy

214.208.4220

ckennedy@bradford.com

Michael Spain

214.543.5463

mSpain@bradford.com

The information contained herein was obtained from sources believed reliable; however, Bradford Companies makes no guarantees, warranties, or representation as to the completeness or accuracy thereof.

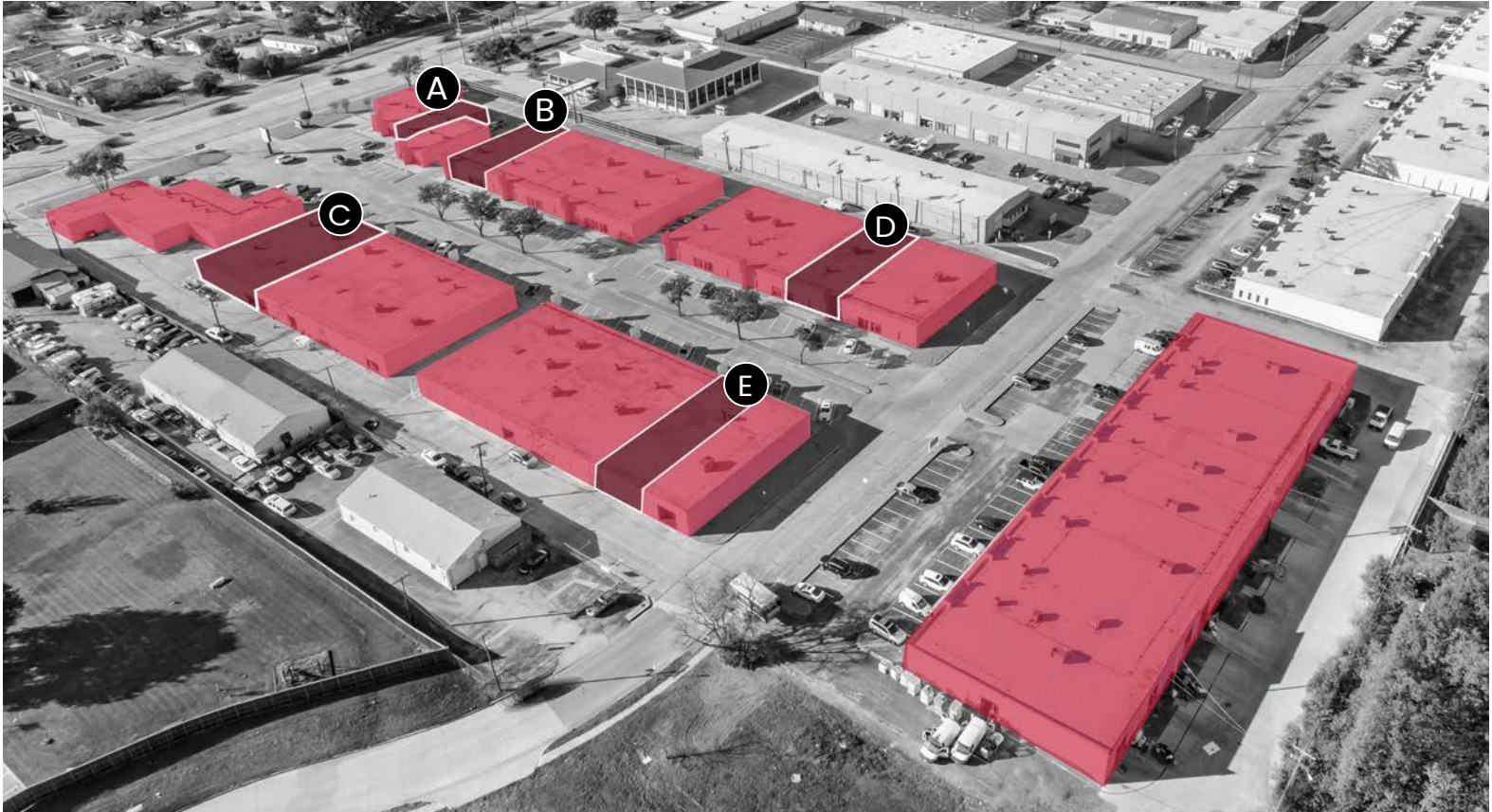

**930 N BELT LINE,
SUITE 111**

SECTION A

- +/- 1,026 SF
- 1 grade level door

**930 N BELT LINE,
SUITE 119**

SECTION B

- +/- 3,000 SF
- 1 grade level door

**930 N BELT LINE,
SUITE 120/122**

SECTION C

- +/- 6,000 SF
- 2 grade level doors

**940 N BELT LINE,
SUITE 137**

SECTION D

- +/- 3,000 SF
- 1 grade level door

**930 N BELT LINE,
SUITE 140**

SECTION E

- +/- 3,000 SF
- 1 grade level door

Leased by:

Chris Kennedy
214.208.4220
ckennedy@bradford.com

Michael Spain
214.543.5463
mSpain@bradford.com

The information contained herein was obtained from sources believed reliable; however, Bradford Companies makes no guarantees, warranties, or representation as to the completeness or accuracy thereof.

MERRICK PARK

930-940 N. BELT LINE RD.
1004-1032 LUKE ST, IRVING, TX 75061



SUITE 111

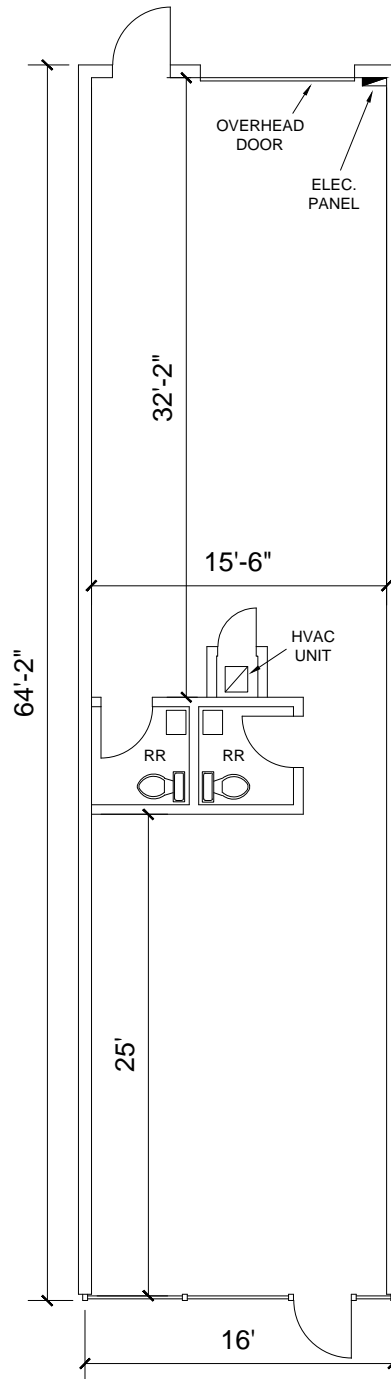

Chris Kennedy
214.208.4220
ckennedy@bradford.com

Michael Spain
214.543.5463
mspain@bradford.com

MERRICK PARK

930-940 N. BELT LINE RD.
1004-1032 LUKE ST, IRVING, TX 75061



SUITE 119

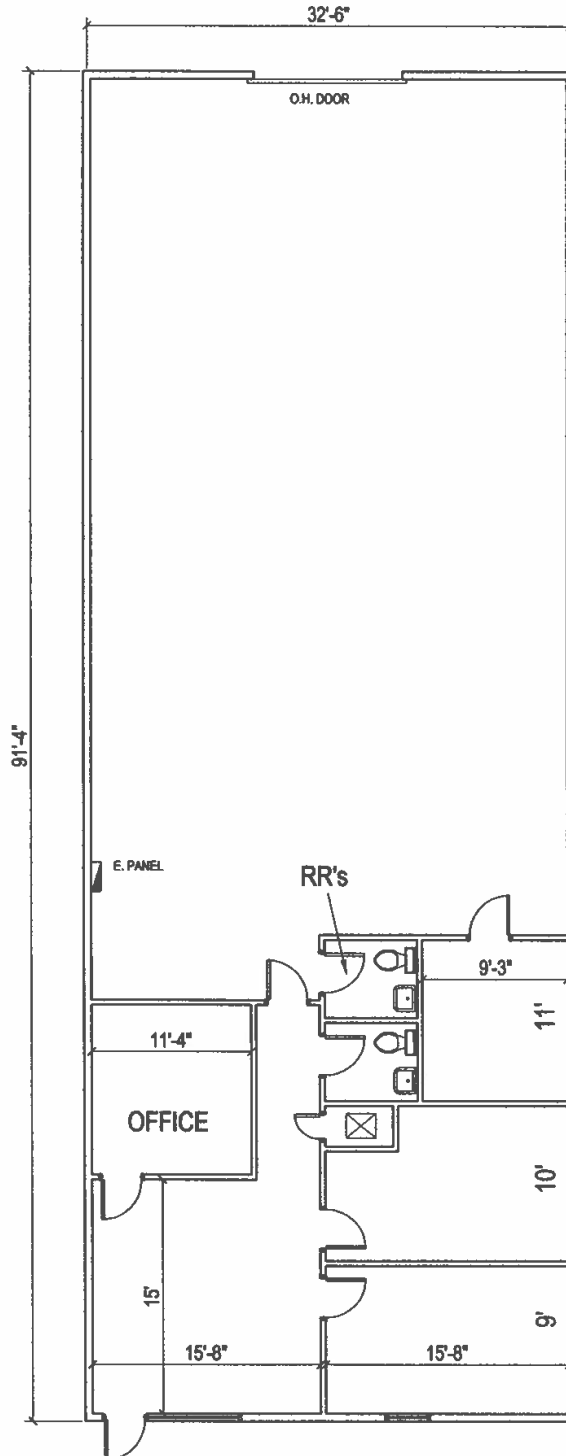

Chris Kennedy
214.208.4220
ckennedy@bradford.com

Michael Spain
214.543.5463
mspain@bradford.com

MERRICK PARK

930-940 N. BELT LINE RD.
1004-1032 LUKE ST, IRVING, TX 75061



SUITE 120/122

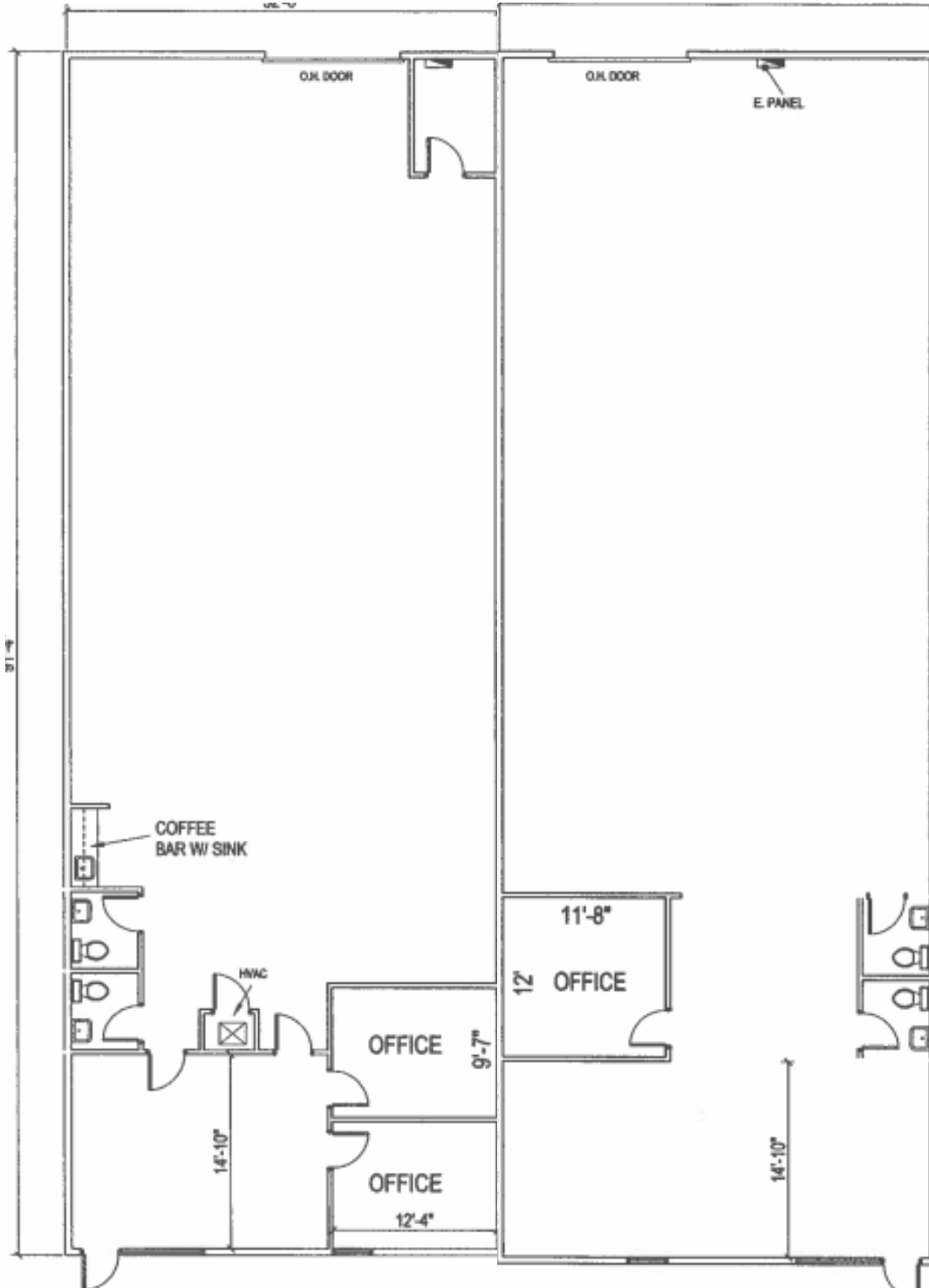

Chris Kennedy
214.208.4220
ckennedy@bradford.com

Michael Spain
214.543.5463
mspain@bradford.com

MERRICK PARK

930-940 N. BELT LINE RD.
1004-1032 LUKE ST, IRVING, TX 75061



SUITE 137

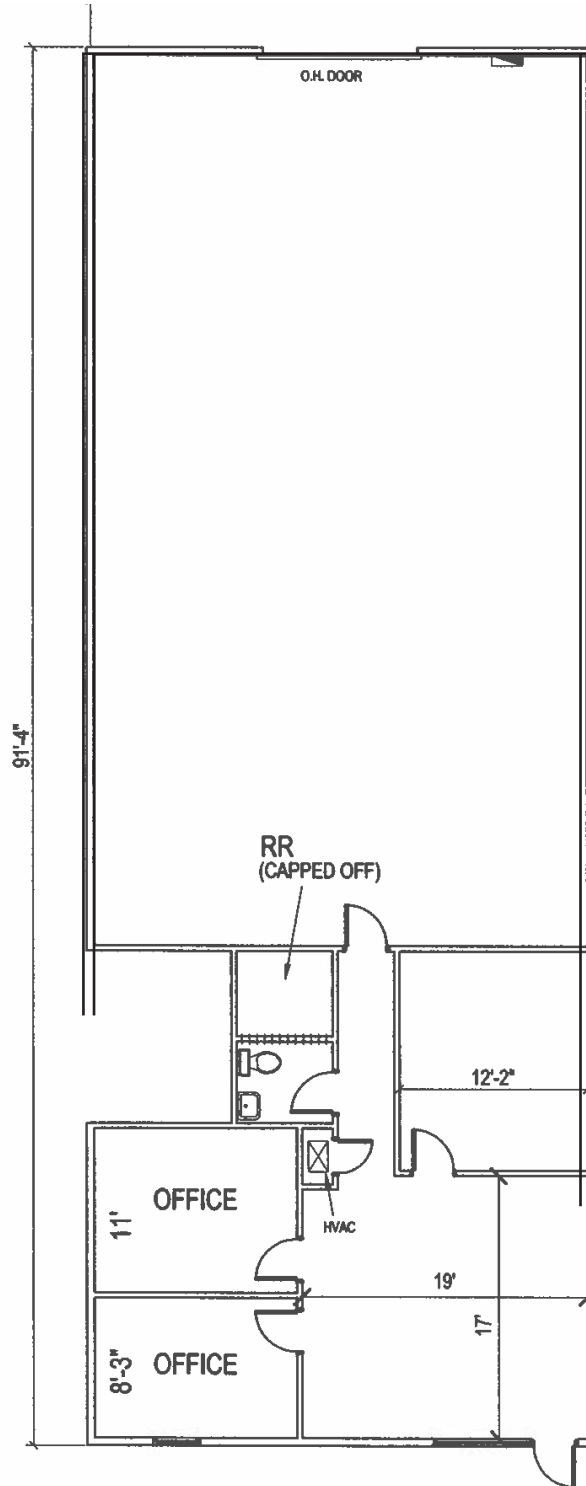

Chris Kennedy
214.208.4220
ckennedy@bradford.com

Michael Spain
214.543.5463
mspain@bradford.com

MERRICK PARK

930-940 N. BELT LINE RD.
1004-1032 LUKE ST, IRVING, TX 75061



SUITE 140

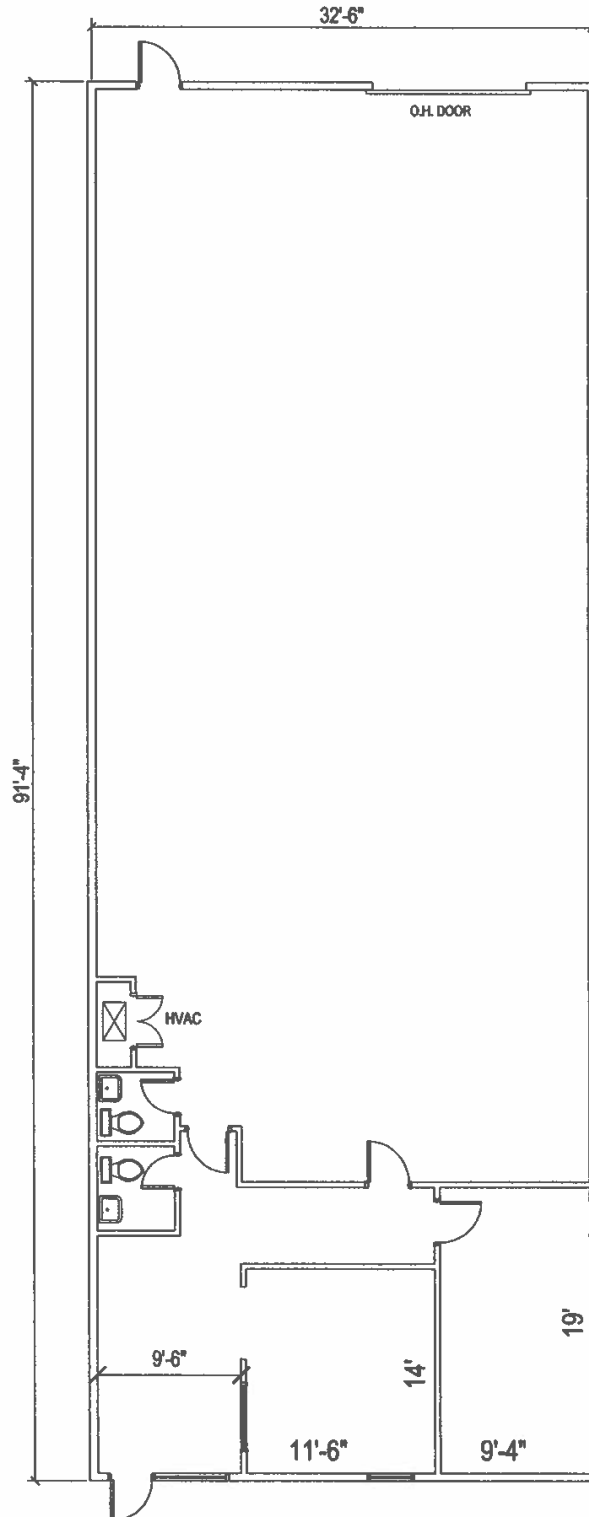

Chris Kennedy
214.208.4220
ckennedy@bradford.com

Michael Spain
214.543.5463
mspain@bradford.com



Leased by:



Chris Kennedy

214.208.4220

ckennedy@bradford.com

Michael Spain

214.543.5463

mSpain@bradford.com

The information contained herein was obtained from sources believed reliable; however, Bradford Companies makes no guarantees, warranties, or representation as to the completeness or accuracy thereof.



Leased by:



Chris Kennedy

214.208.4220

ckennedy@bradford.com

Michael Spain

214.543.5463

mSpain@bradford.com

The information contained herein was obtained from sources believed reliable; however, Bradford Companies makes no guarantees, warranties, or representation as to the completeness or accuracy thereof.



Information About Brokerage Services

Texas law requires all real estate license holders to give the following information about brokerage services to prospective buyers, tenants, sellers and landlords.

TYPES OF REAL ESTATE LICENSE HOLDERS:

- **A BROKER** is responsible for all brokerage activities, including acts performed by sales agents sponsored by the broker.
- **A SALES AGENT** must be sponsored by a broker and works with clients on behalf of the broker.

A BROKER'S MINIMUM DUTIES REQUIRED BY LAW (A client is the person or party that the broker represents):

- Put the interests of the client above all others, including the broker's own interests;
- Inform the client of any material information about the property or transaction received by the broker;
- Answer the client's questions and present any offer to or counter-offer from the client; and
- Treat all parties to a real estate transaction honestly and fairly.

A LICENSE HOLDER CAN REPRESENT A PARTY IN A REAL ESTATE TRANSACTION:

AS AGENT FOR OWNER (SELLER/LANDLORD): The broker becomes the property owner's agent through an agreement with the owner, usually in a written listing to sell or property management agreement. An owner's agent must perform the broker's minimum duties above and must inform the owner of any material information about the property or transaction known by the agent, including information disclosed to the agent or subagent by the buyer or buyer's agent.

AS AGENT FOR BUYER/TENANT: The broker becomes the buyer/tenant's agent by agreeing to represent the buyer, usually through a written representation agreement. A buyer's agent must perform the broker's minimum duties above and must inform the buyer of any material information about the property or transaction known by the agent, including information disclosed to the agent by the seller or seller's agent.

AS AGENT FOR BOTH - INTERMEDIARY: To act as an intermediary between the parties the broker must first obtain the written agreement of *each party* to the transaction. The written agreement must state who will pay the broker and, in conspicuous bold or underlined print, set forth the broker's obligations as an intermediary. A broker who acts as an intermediary:

- Must treat all parties to the transaction impartially and fairly;
- May, with the parties' written consent, appoint a different license holder associated with the broker to each party (owner and buyer) to communicate with, provide opinions and advice to, and carry out the instructions of each party to the transaction.
- Must not, unless specifically authorized in writing to do so by the party, disclose:
 - that the owner will accept a price less than the written asking price;
 - that the buyer/tenant will pay a price greater than the price submitted in a written offer; and
 - any confidential information or any other information that a party specifically instructs the broker in writing not to disclose, unless required to do so by law.

AS SUBAGENT: A license holder acts as a subagent when aiding a buyer in a transaction without an agreement to represent the buyer. A subagent can assist the buyer but does not represent the buyer and must place the interests of the owner first.

TO AVOID DISPUTES, ALL AGREEMENTS BETWEEN YOU AND A BROKER SHOULD BE IN WRITING AND CLEARLY ESTABLISH:

- The broker's duties and responsibilities to you, and your obligations under the representation agreement.
- Who will pay the broker for services provided to you, when payment will be made and how the payment will be calculated.

LICENSE HOLDER CONTACT INFORMATION: This notice is being provided for information purposes. It does not create an obligation for you to use the broker's services. Please acknowledge receipt of this notice below and retain a copy for your records.

Bradford Realty Services of Dallas, Inc	#399375	info@bradford.com	9727767000
Licensed Broker /Broker Firm Name or Primary Assumed Business Name	License No.	Email	Phone
Designated Broker of Firm	License No.	Email	Phone
Licensed Supervisor of Sales Agent/ Associate	License No.	Email	Phone
Sales Agent/Associate's Name	License No.	Email	Phone

Buyer/Tenant/Seller/Landlord Initials

Date