



# 10951 W. PICO BLVD

LOS ANGELES, CA 90064

Suite 120 + 204 + 205  
Office / Medical / Retail  
For Lease

**PREMISES**

Suite 120 ± 4,566 RSF (divisible)  
Suite 204 ± 2,100 RSF  
Suite 205 ± 1,620 RSF

**OCCUPANCY**

Suite 120: Available Now  
Suite 204: Available Now  
Suite 205: Available July 1st, 2026

**PARKING**

Suite 120: 11 Spaces - \$150/Space  
Suite 204: 6 Spaces - \$150/Space  
Suite 205: 5 Spaces - \$150/Space

**FEATURES**

- Drywall and Acoustical Ceiling for Better Acoustics, Sustainability, and Temperature Control
- Private Patios
- Operable Windows (in some suites)
- Easy access to Santa Monica 10 Freeway and Pacific Coast Highway
- ½ Mile (8 Minute Walk) from Sepulveda Expo Stations
- Walking Distance to Many Popular Restaurants
- Walking Distance to UCLA's Research Park

**RENT**

Office: \$2.25/SF FSG Year 1  
Medical & Retail: Rate Dependant  
on TI Scope

**TERM**

Minimum 1 Year









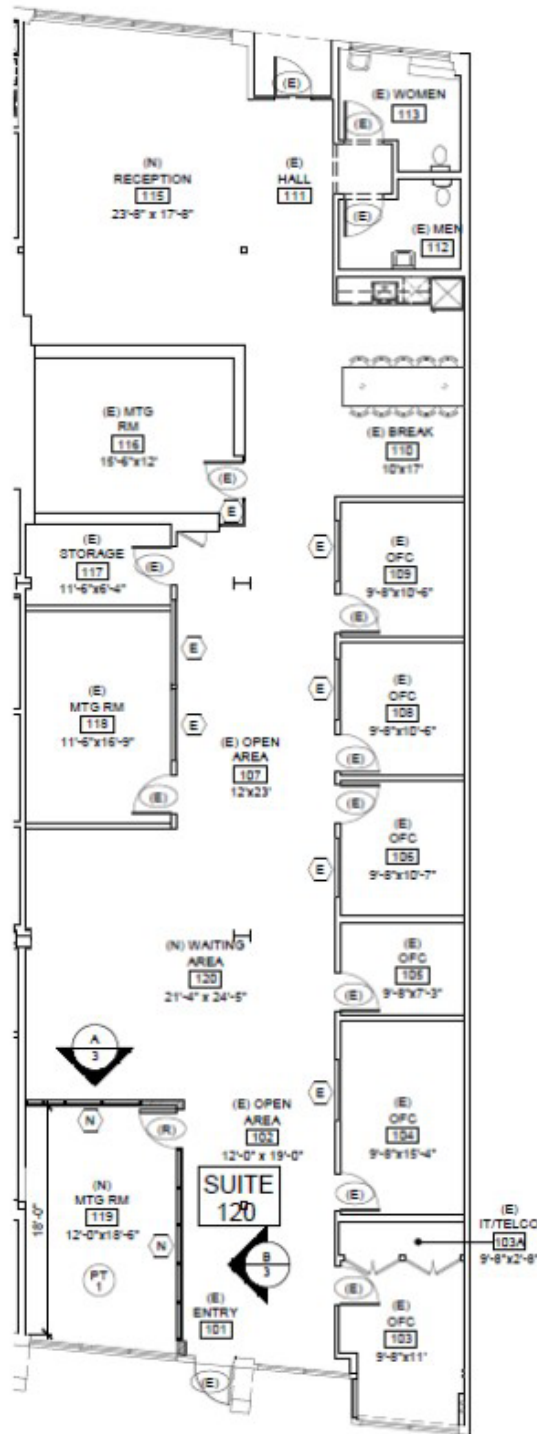

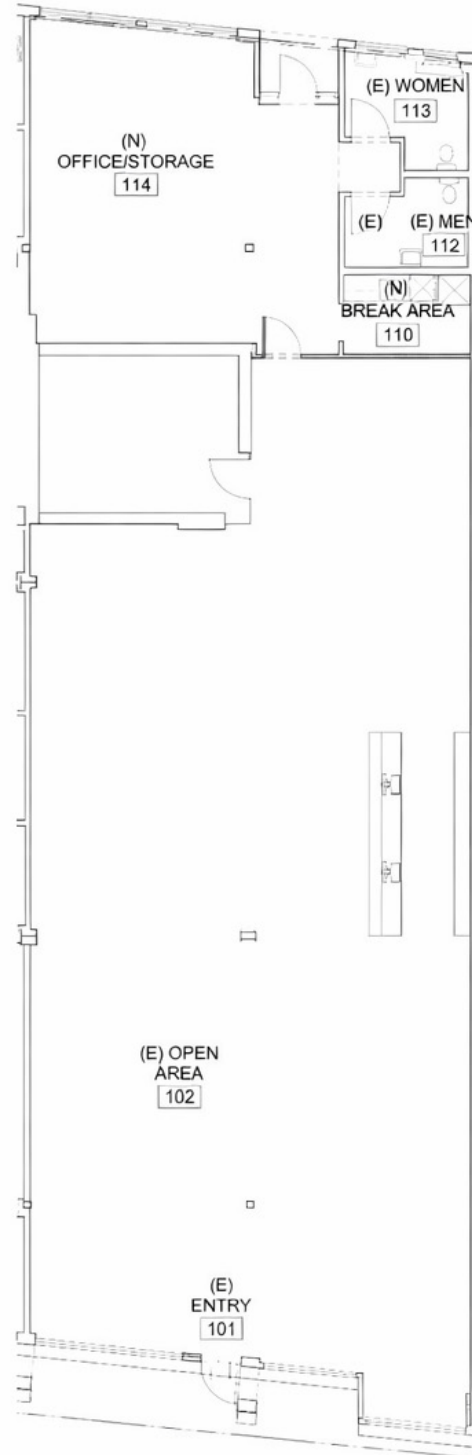

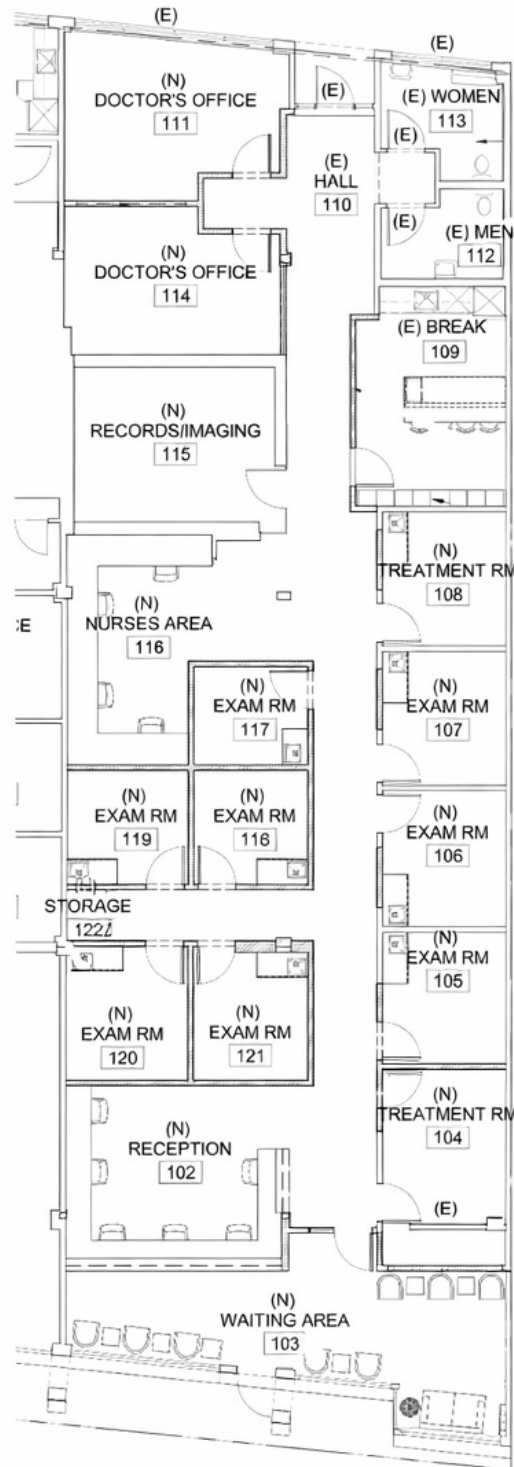

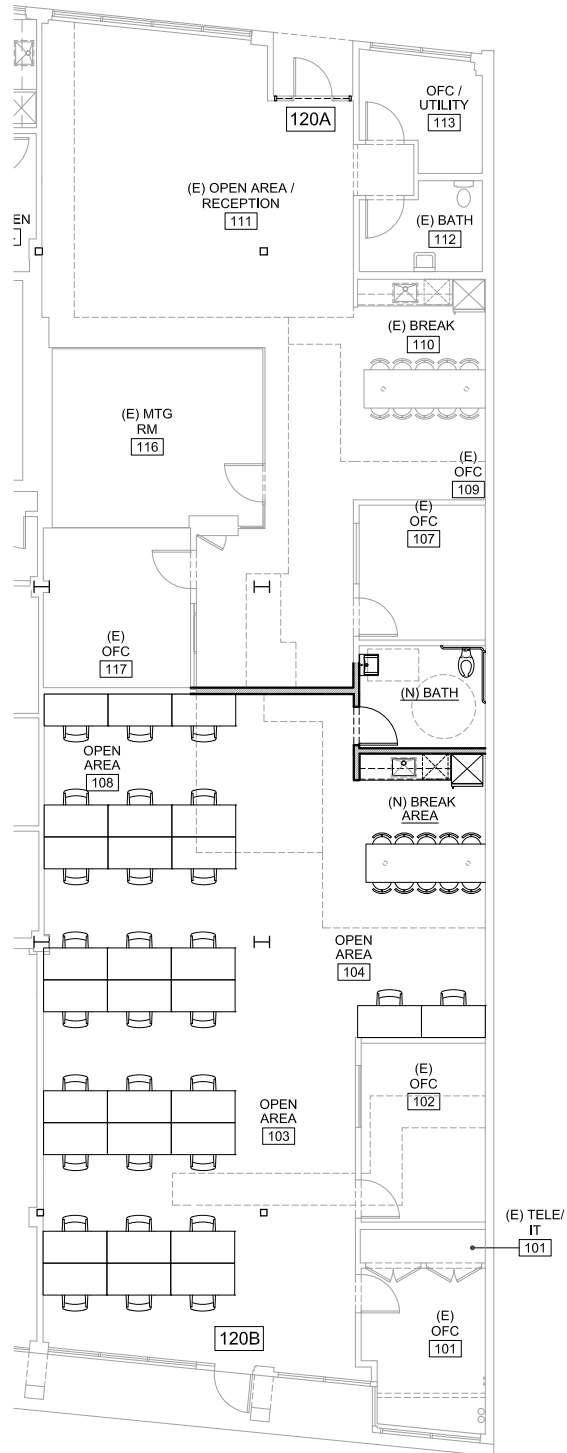

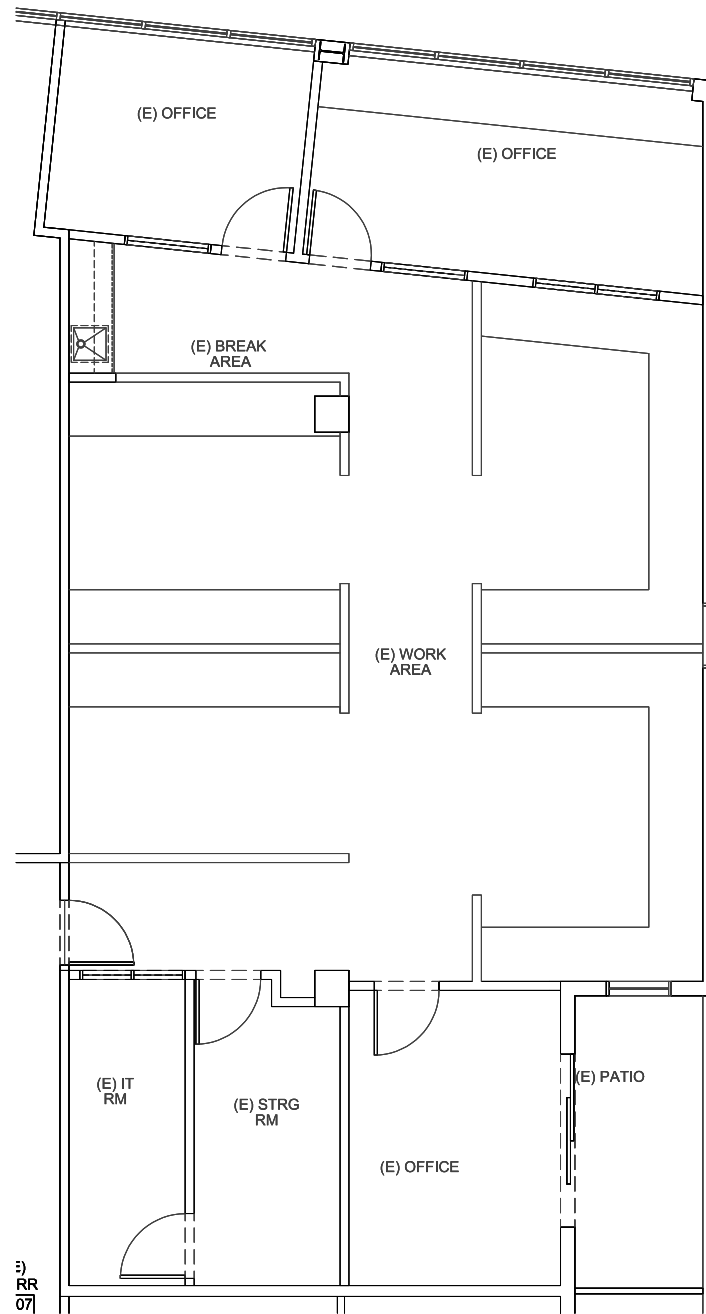

RR  
07

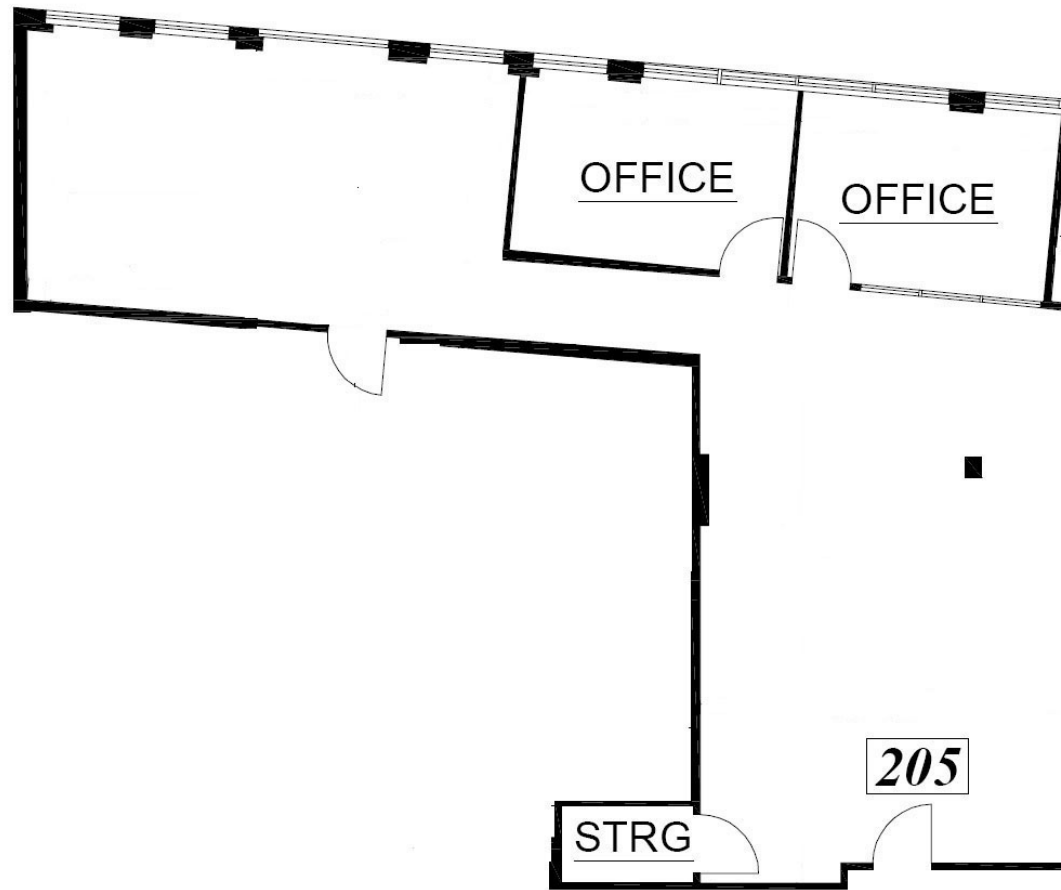



**UCLA  
RESEARCH  
PARK**

**10951  
W. PICO BLVD**

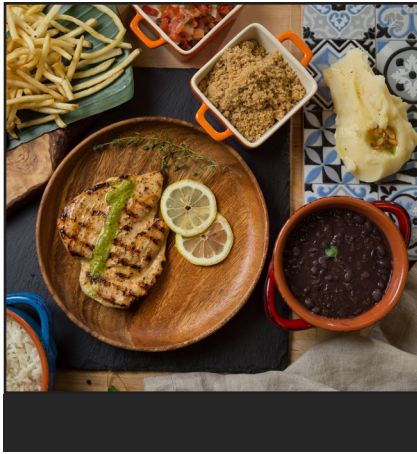

**Bossa Nova** is a lively, neighborhood favorite serving classic Brazilian dishes and comfort food in a relaxed, energetic setting.



**Bakery LA** is a local bakery known for freshly baked breads, pastries, and European-inspired sweets made daily.

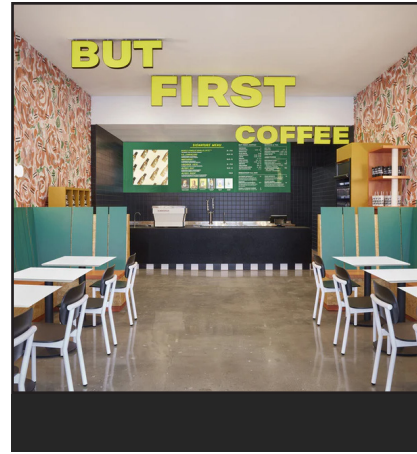

**Alfred Coffee** is a stylish café known for craft coffee, house-made beverages, and a relaxed yet polished atmosphere.

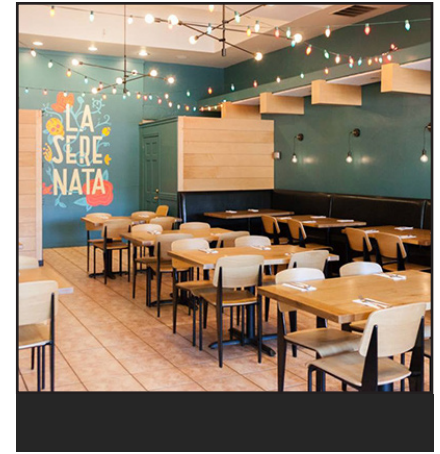

**La Serenata Cantina** is a charming neighborhood spot offering elevated Mexican cuisine, handcrafted cocktails, and a warm, inviting ambiance.



**Trader Joe's** is a go-to specialty grocer offering curated everyday essentials, unique finds, and exceptional value.



**Motoring Coffee** is a design-forward café blending specialty coffee with a laid-back, automotive-inspired aesthetic.

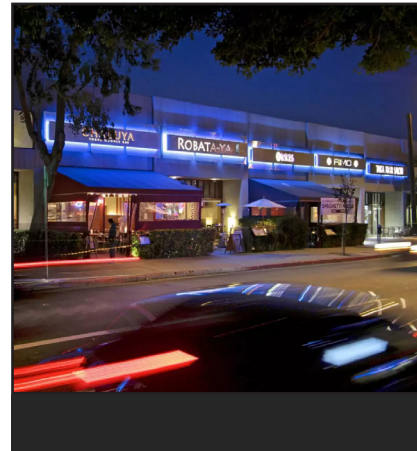

**Sawtelle Japantown** is a lively cultural district known for its diverse food scene, eclectic shops, and a vibrant blend of traditions and modern urban culture.

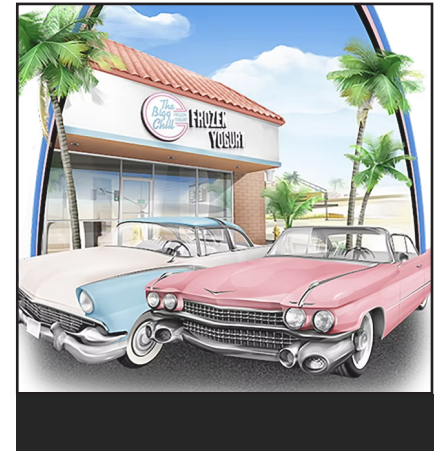

**The Big Chill** frozen yogurt is a beloved dessert destination serving classic frozen yogurt and nostalgic treats in a casual, family-friendly atmosphere.



**George Wilson**

PRINCIPAL  
gwilson@leewestla.com  
310.899.2738  
DRE: 02090678

**David Wilson**

PRINCIPAL  
dwilson@leewestla.com  
310.899.2707  
DRE: 00822760

**James Wilson**

PRINCIPAL  
jwilson@leewestla.com  
310.899.2708  
DRE: 00883324

**Lindsay Shuford**

ASSOCIATE  
lshuford@leewestla.com  
310.899.2710  
DRE: 02231518