

DO NOT SCALE

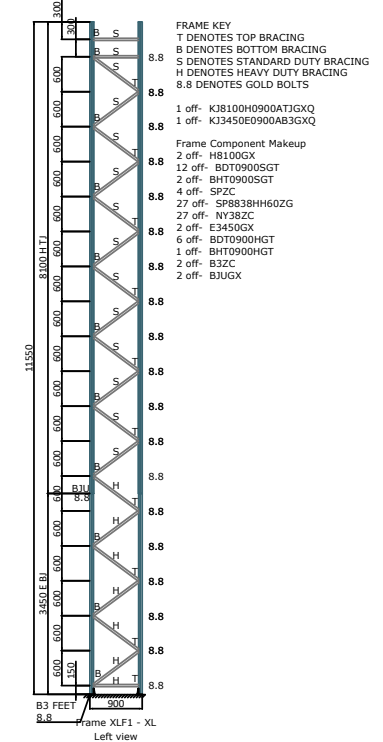

- FRAME KEY
 T DENOTES TOP BRACING
 B DENOTES BOTTOM BRACING
 S DENOTES STANDARD DUTY BRACING
 H DENOTES HEAVY DUTY BRACING
 8.8 DENOTES GOLD BOLTS
- 1 off- K318100H0900ATJGXQ
 1 off- K3450E0900AB3GXQ
- Frame Component Makeup
 2 off- H8100GX
 12 off- BDT0900SGT
 2 off- BHT0900SGT
 4 off- SPZC
 27 off- SP8838HH60ZG
 27 off- NY38ZC
 2 off- E3450GX
 6 off- BDT0900HGT
 1 off- BHT0900HGT
 2 off- B3ZC
 2 off- BJUGX

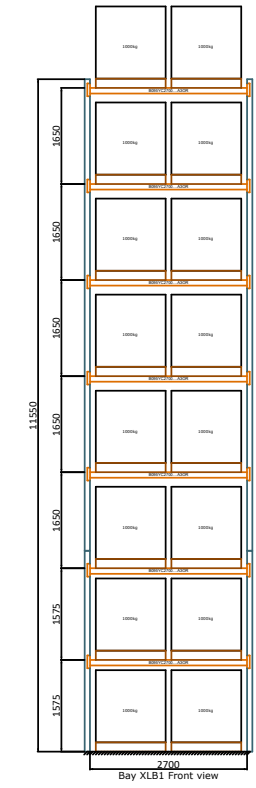
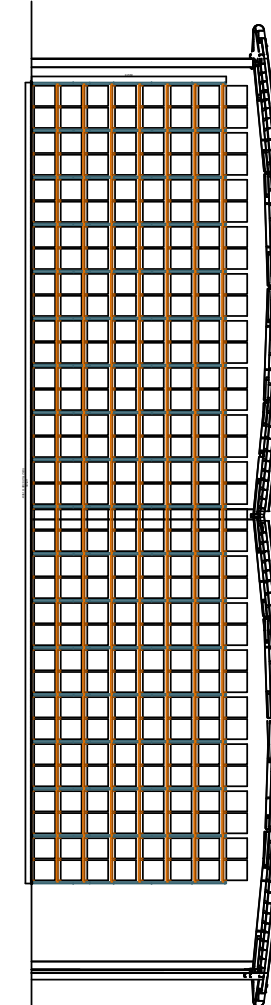
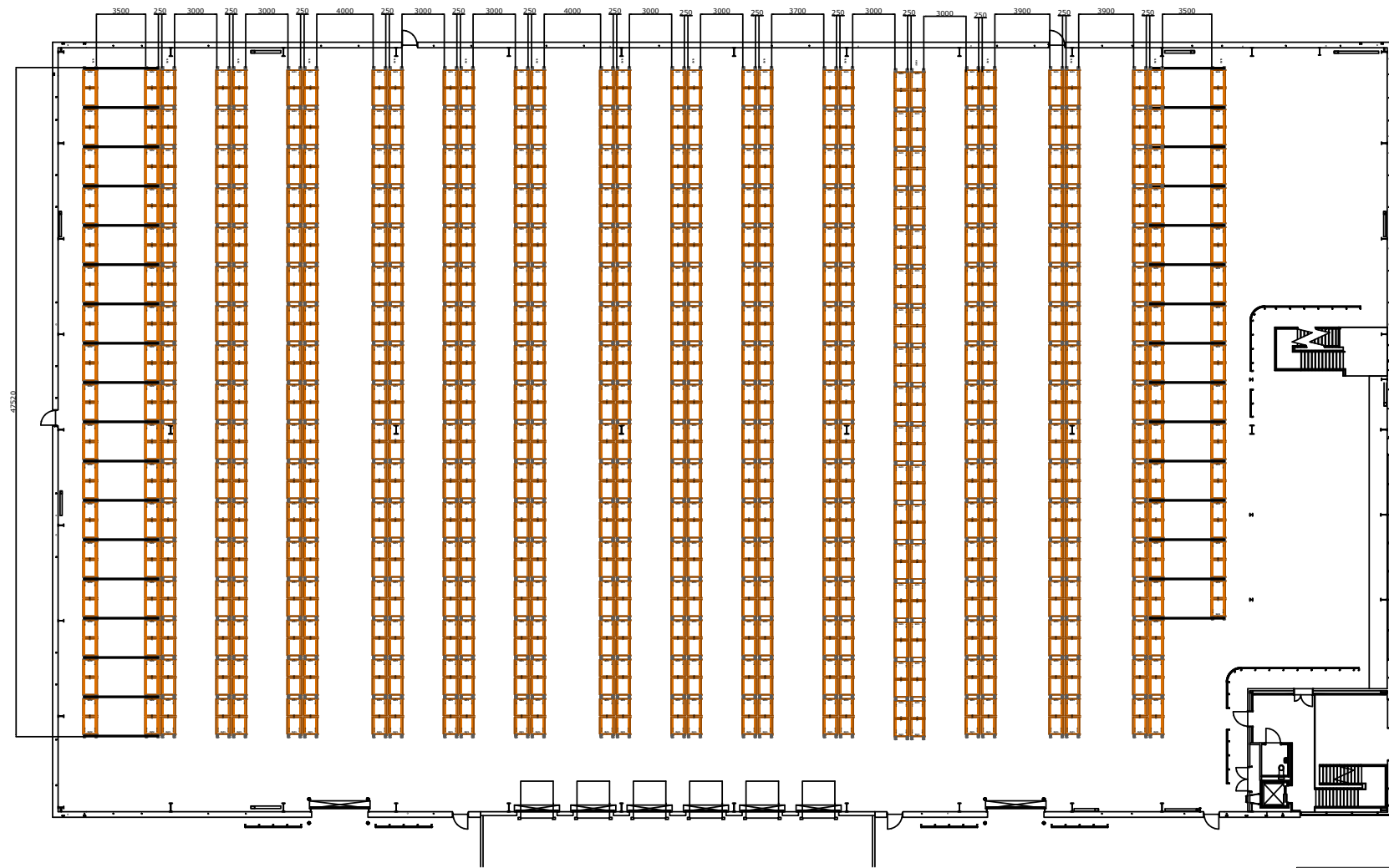
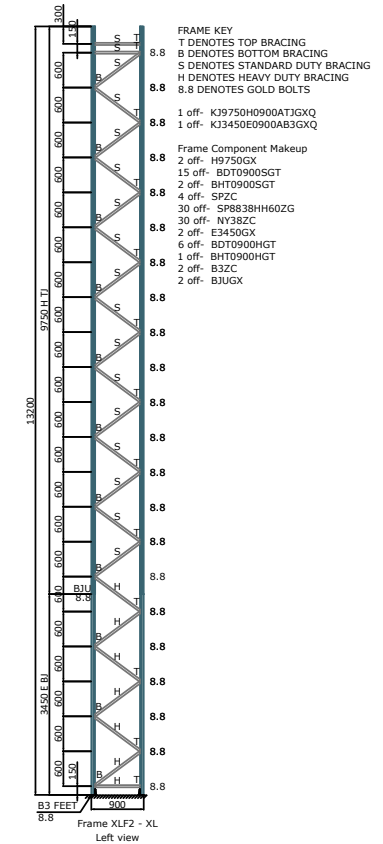
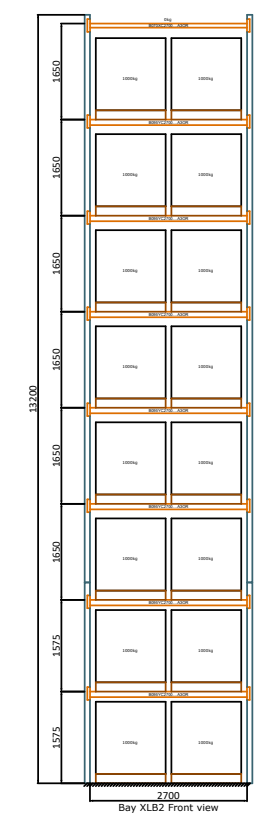

- FRAME KEY
 T DENOTES TOP BRACING
 B DENOTES BOTTOM BRACING
 S DENOTES STANDARD DUTY BRACING
 H DENOTES HEAVY DUTY BRACING
 8.8 DENOTES GOLD BOLTS
- 1 off- K39750H0900ATJGXQ
 1 off- K3450E0900AB3GXQ
- Frame Component Makeup
 2 off- H9750GX
 15 off- BDT0900SGT
 2 off- BHT0900SGT
 4 off- SPZC
 30 off- SP8838HH60ZG
 30 off- NY38ZC
 2 off- E3450GX
 6 off- BDT0900HGT
 1 off- BHT0900HGT
 2 off- B3ZC
 2 off- BJUGX

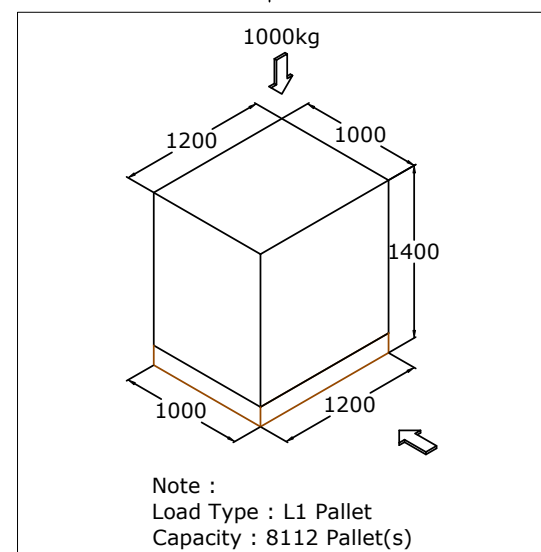

Whittan Group Ltd.
 Link House, Halesfield 6, Telford, TF7 4LN, United Kingdom
 www.whittan.com <http://www.whittan.com> T: +44 (0)1952 682 251

Rev No.	Date	Sign	Description

Scale: _____ Drawn By: PDL Checked By: JR Date: 11/12/2023

Customer Approval: _____ Approval Date: _____

Drawing and Contract number: A3 D360-57428-00025-00

Storage Solution for
 Sherburn Project - Firethorn Trust (UNIT 400 Wide Aisle Layout)

This Drawing remains the property of Whittan Group ©

While every attempt has been made to ensure the accuracy of the drawing contained here, measurements are indicative only and no responsibility is taken for any error, omission, or misstatement. The drawing is for initial guidance only and should not be relied on for any other purpose. Specifically, no guarantee is given as to the accuracy of this drawing. On receipt of any formal instructions to proceed with a project the drawing/drawings will be checked and subject to the Terms & Conditions agreed. Copyright of the document remains vested with Whittan Industrial Ltd